

# Modular Multiples®

## Trimmed

Recessed - New Work

Built to your specifications, these high-quality fixtures feature a trimmed aperture for a clean, refined appearance. Available with transformer incorporated, transformer attached, and remote transformer configurations for new and old work installations. The series is adaptable to plaster, gypboard, wood, or acoustical ceilings. This series conforms to USA standards. A companion series that conforms to Asian and European standards is also available.

## Custom Mixed Lamp



M-2-D/1-G-2-TI-REC-TR

Modular Multiples® Trimmed Series, custom configuration, two AR111 lamps, one PAR30 HID lamp, black housing, transformer attached, rectangular aperture, trimmed configuration shown.

Other configurations available.

[Download CSI drop-in spec template](#)

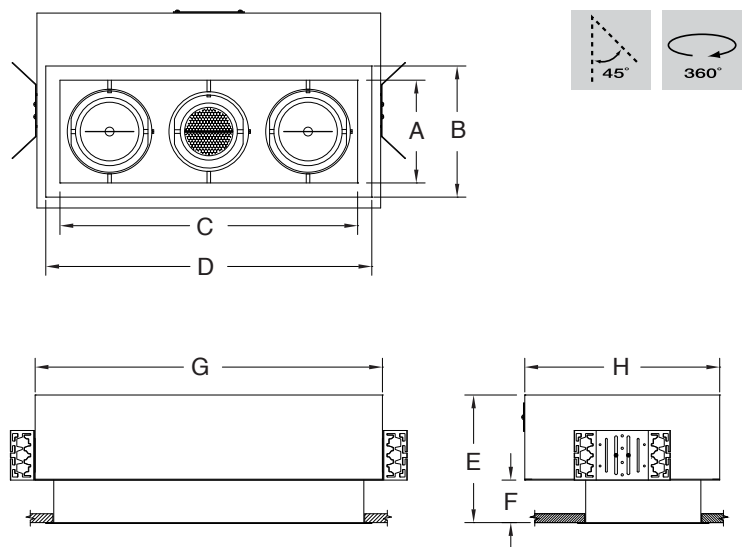

LAMPS and DIMENSIONS	A	B	C	D	E	F	G	H
AR111 / PAR30-HID	7-1/4" 184mm	9-1/4" 235mm	21" 533mm	23" 584mm	9" 229mm	3" 76mm	24-1/2" 622mm	13-3/4" 349mm

# Modular Multiples®

The Original Multiple Lamp Family of Fixtures

4

## Trimmed Recessed - New Work



- Configurations:**
- 1, 2, 3, 4 light units standard
  - Custom configurations available
- Housing:**
- Fabricated 18 gauge steel supplied with adjustable mounting brackets
  - 14 gauge steel trim flange
  - Available for airtight or IC rated applications

- Finishes:**
- Powder coated - white or black standard
  - Custom colors available
  - Stainless steel / satin nickel available

- Electrical:**
- Internal electronic power supply(s) /transformer(s) / ballast(s)
  - Dimmable (not applicable on HID products)
  - One power supply / transformer per lamp allowing for multi-circuit wiring.
  - 120v and 277v available
  - Listed to UL1598 standards

**Lamping:**

**Standard LED Modules**

6w LED-506-6	12w LED-512-12	12w LED-512-22
8w LED-708-6	14w LED-714-12	14w LED-714-22
16w LED-716-12	16w LED-716-22	16w LED-716-45
30w LED-930-12	30w LED-930-22	30w LED-930-45

**Direct Replacement LED or Legacy Lamps:**

MR16LED (BLD)	MR16 HALOGEN (B)	MR16CMH (BH)
AR111LED (DLD)	AR111 HALOGEN (D)	CDMR111 (S)
PAR30LED (GLD)	PAR30 (G)	PAR30HID (H)
PAR38LED (JLD)	PAR38 (J)	PAR38HID (K)

**Mounting:**

- For new construction applications.
- Recessed housing is installed via adjustable universal mounting brackets and bar hangers prior to the installation of drywall.
- Fixture designed for use in ceiling material with a maximum thickness of 2"

**Options:**

- Patented die-cast aluminum ring sets and locking devices
- Pull down yokes
- Shielding cones
- Filter media
  - LED modules accept one 1/8" thick filter
  - LED direct replacement and legacy lamps accept up to two 1/8" thick filters

**Model #  
example:**

**M-2-LED/16-x-TI-REC- TR**

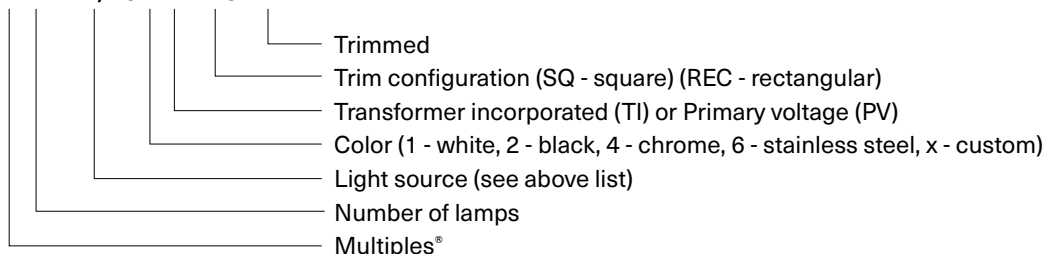

[Download CSI  
drop-in spec template](#)

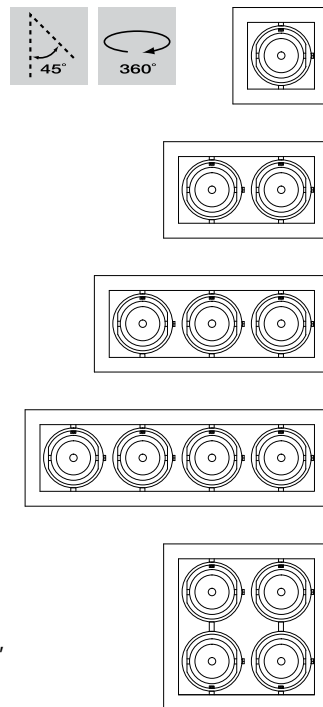

# Modular Multiples®

## Trimmed Typical Installation

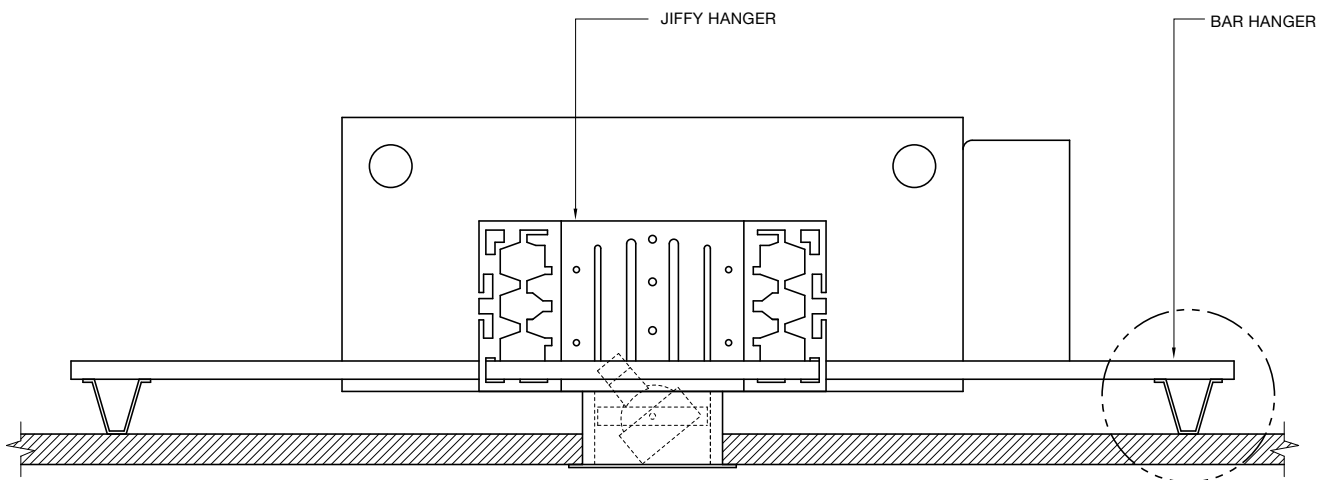
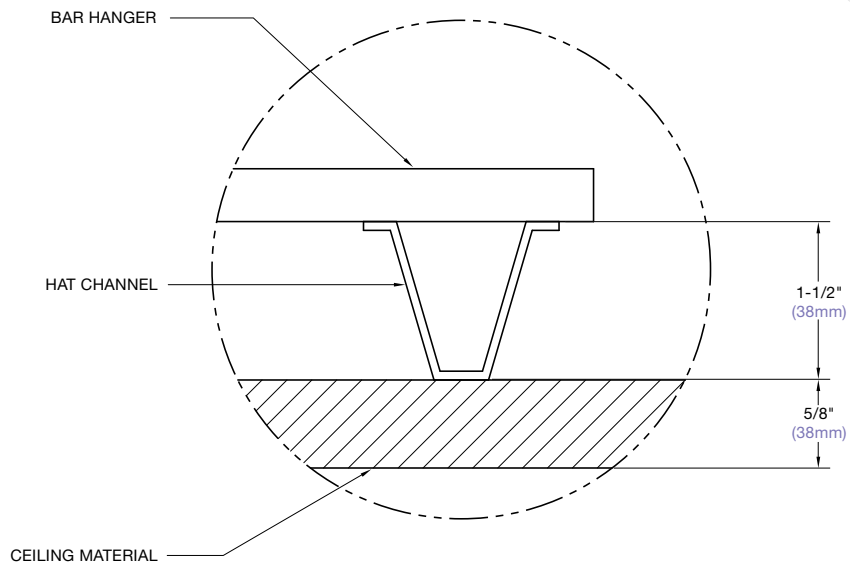

# Modular Multiples®

The Original Multiple Lamp Family of Fixtures



## Standard LED Modules

### LED-506-6

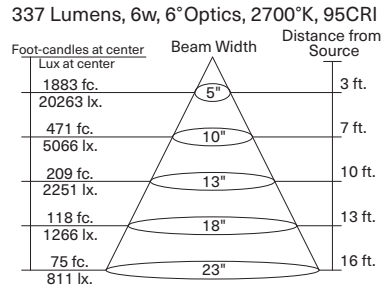

### LED-512-12

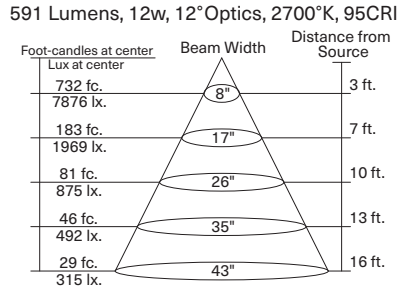

### LED-512-22

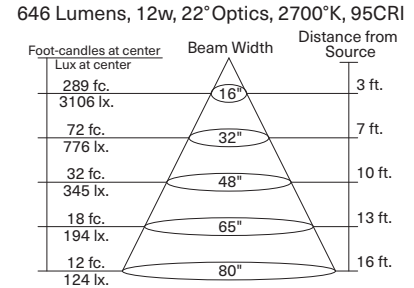

### LED-708-6

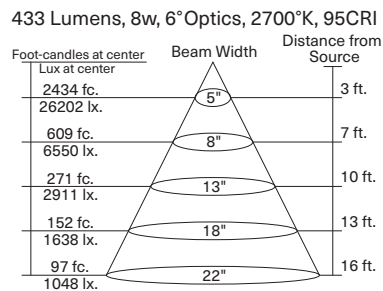

### LED-714-12

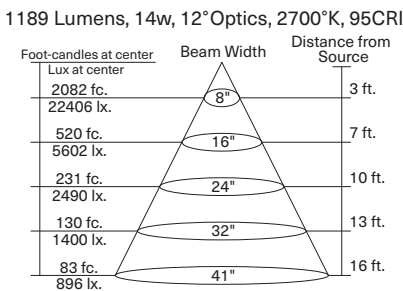

### LED-714-22

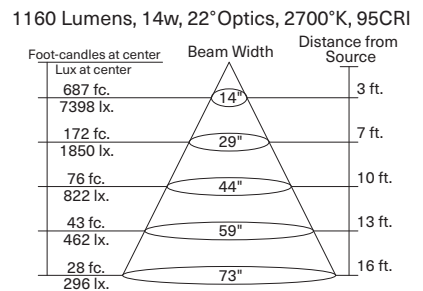

### LED-716-12

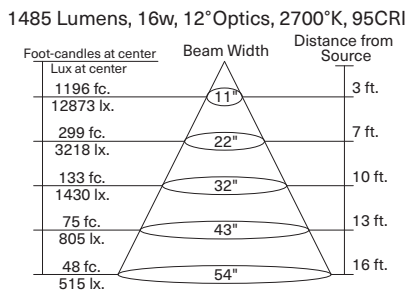

### LED-716-22

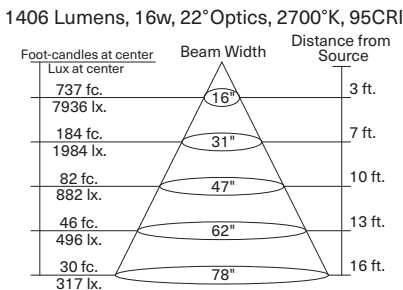

### LED-716-45

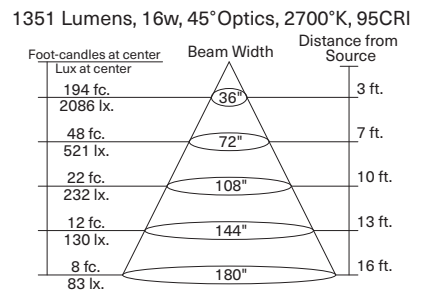

### LED-930-12

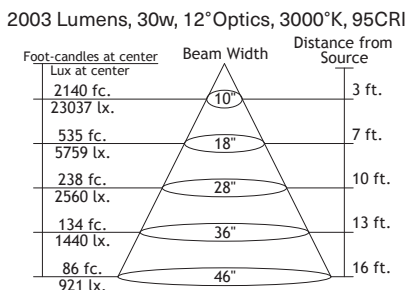

### LED-930-22

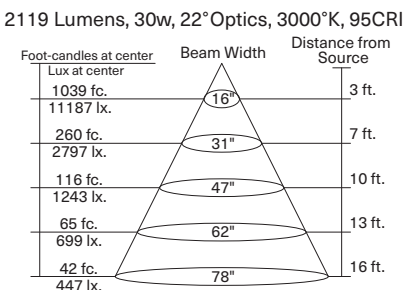

### LED-930-45

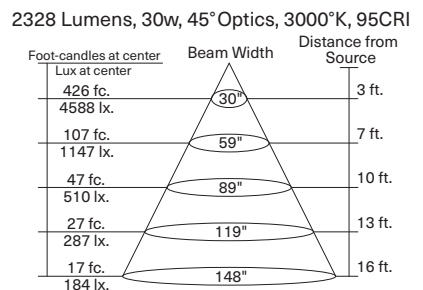

# Modular International, Inc.



## Elements™ 16w LED Module

**16<sub>w</sub>**

**Model :** LED-516

**Wattage:** 16

**Lumens:** 640 at 3000°K

**Kelvin Temperature:** 2850°K or 3000°K (+/- 2%)

**Standard CRI:** 95

**Accessories and customization available:** Tuning, dimming, beam angles, Kelvin temperature, shielding and filtering

**Beam Angles:** 14° Spot, 21° Narrow Flood, 34° Flood, 6° beam angle also available

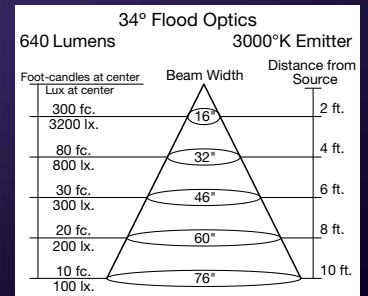
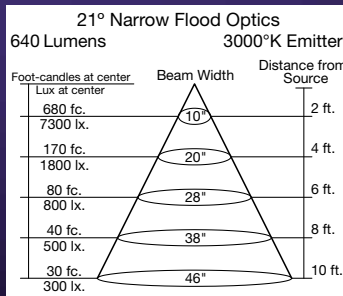
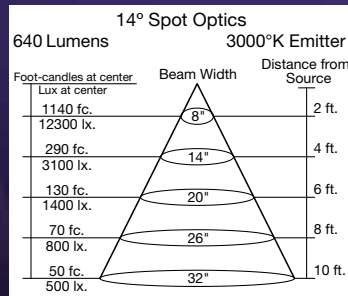

## Elements™ 30w LED Module

**30<sub>w</sub>**

**Model :** LED-530

**Wattage:** 30

**Lumens:** 1200 at 3000°K

**Kelvin Temperature:** 2850°K or 3000°K (+/- 2%)

**Standard CRI:** 95

**Accessories and customization available:** Tuning, dimming, beam angles, Kelvin temperature, shielding and filtering

**Beam Angles:** 14° Spot, 21° Narrow Flood, 34° Flood, 6° beam angle also available

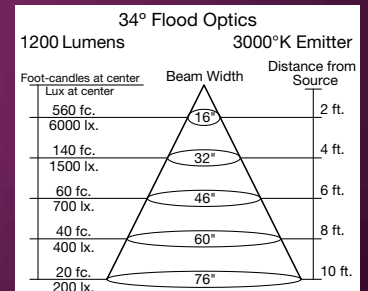
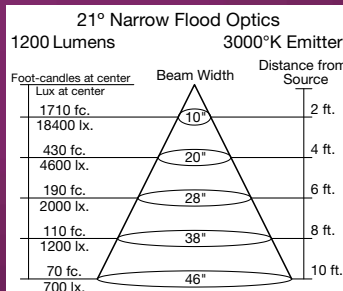
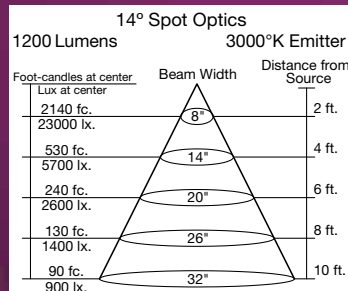

# Modular Multiples®

## Fixture Options

Modular accessories are used individually or in inventive combinations to shield brightness, reduce glare, vary beam patterns, retain direction, and alter color. Dimensions of all fixture options vary with lamp size.

### Ring Sets and Locking Devices (PATENTED)

ADD -LM TO END OF MODEL NUMBER

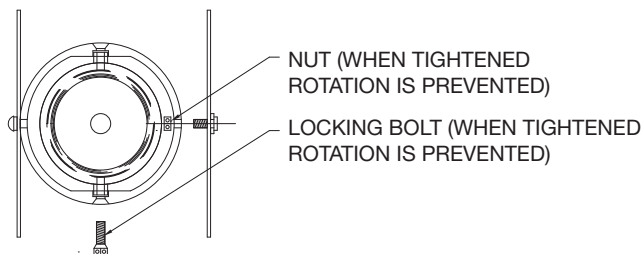

**BOTTOM VIEW**

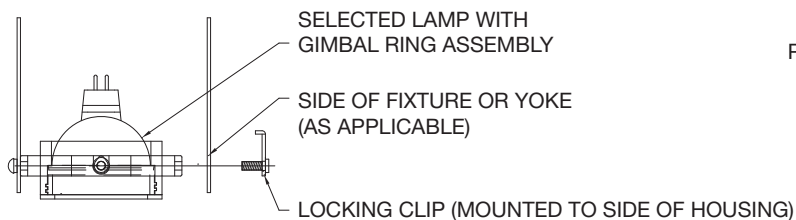

**FRONT VIEW**

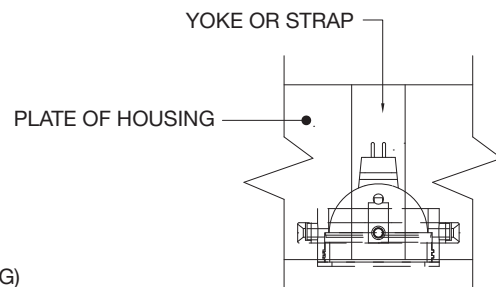

**SIDE VIEW**

### Extendable Yokes

ADD -EY TO END OF MODEL NUMBER

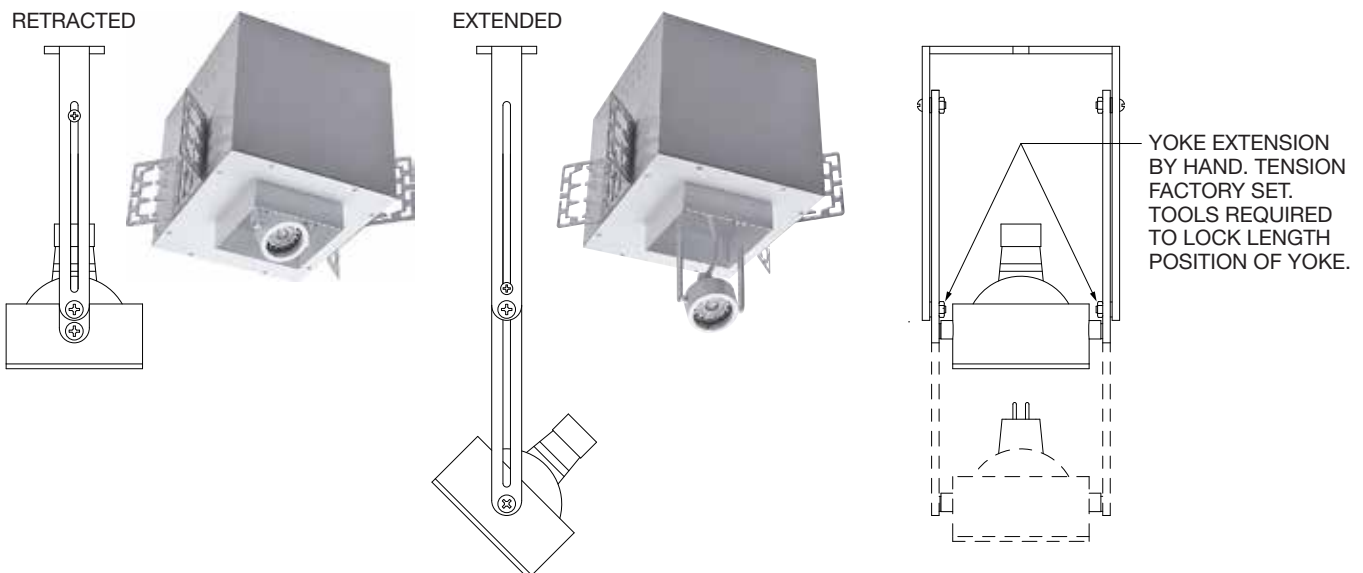

# Modular Multiples®

## Fixture Options

Modular accessories are used individually or in inventive combinations to shield brightness, reduce glare, vary beam patterns, retain direction, and alter color. Fixture option dimensions vary with lamp size.

### Shielding Options

ADD SHIELDING OPTION CODE (BELOW) TO END OF MODEL NUMBER

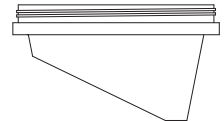
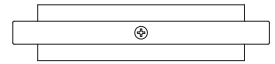
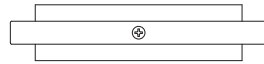
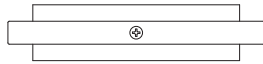
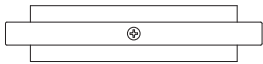

FILTER RING (STANDARD)

SHIELDING CONE (-SC)

SHIELDING CYLINDER (-CY)

WALL WASH CONE (-WWC)

### Filter Media

ADD FILTER MEDIA CODE (BELOW) TO END OF MODEL NUMBER

LED modules accept one 1/8" thick filter. LED direct replacement and legacy lamps accept up to two 1/8" thick filters.

CLEAR GLASS (-CG)

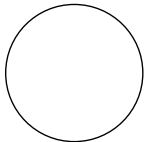

DIFFUSING SPREAD (-DS)

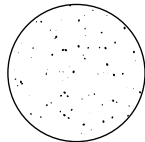

CUBE CELL LOUVER (-CL)

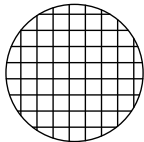

HEXCELL LOUVER (-HL)

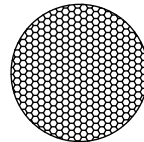

LINEAR SPREAD (-LS)

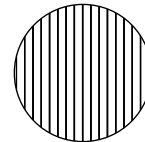

PRISMATIC WIDE SPREAD (-PS)

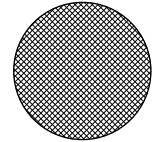

SATIN ETCHED (-SE)

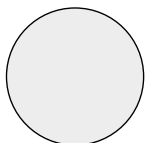

UV BLOCKING (-UB)

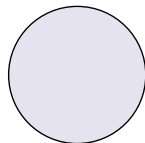

DICHROIC

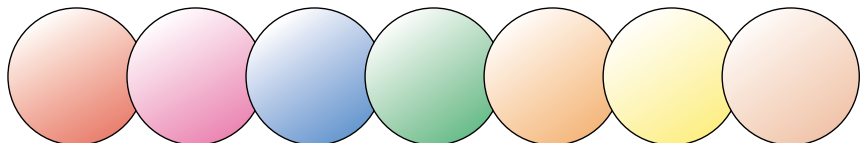

RED (-DR)

MAGENTA (-DM)

BLUE (-DB)

GREEN (-DG)

AMBER (-DA)

YELLOW (-DY)

PEACH (-DP)