

Modular Multiples®

The Original Multiple Light Family of Fixtures

Apertures®

Recessed - Trimless - New/Old Work

These elegant, trimless fixtures are thoroughly flexible in application. Apertures® preformed panels are easily grouped in linear or nonlinear patterns of any length or diameter, giving architects and designers the ability to create artful, imaginative, and seamless ceiling patterns. Round, square, and rectangular apertures with patented accessories such as locking rings and shielding filter media systems are standard. Custom configurations available. Fixture dimensions vary with light type.

Three Light Round Apertures

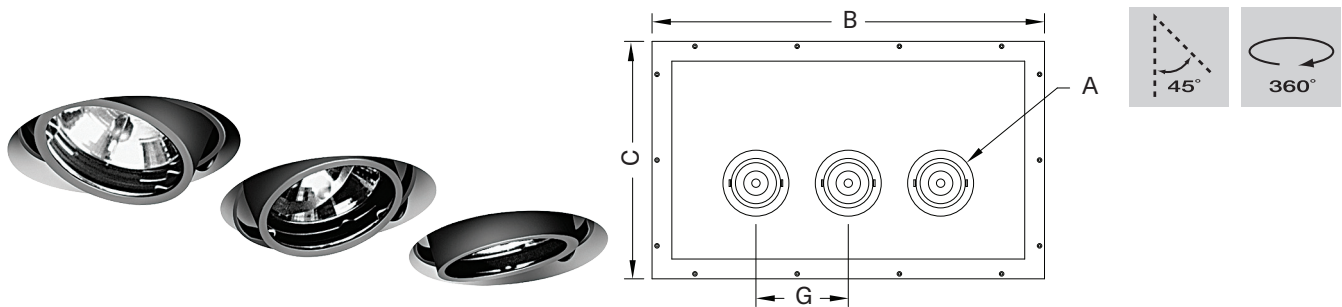

MAS-3-LED-512-20-27-1-TI-RD-AWNR-WH

Modular Multiples® Apertures® Series, three 12 watt LED modules, black housing, drivers/transformers incorporated, round apertures, Lutron Athena Wireless Node-white configuration shown. Other configurations available.

[Download CSI drop-in spec template](#)

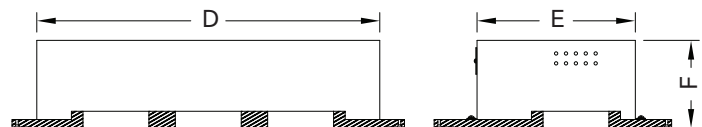

COMPATIBLE CEILING MATERIALS



LIGHTS and DIMENSIONS	A	B	C	D	E	F	G
LED-507, LED-508, LED-510, LED-511, LED-512	Ø4" Ø102mm	25-3/4" 654mm	16-1/2" 419mm	22" 559mm	10-1/2" 267mm	5-5/8" 143mm	5-1/2" 140mm
LED-712, LED-714, LED-716, LED-720, LED-920, LED-926, LED-929, LED-932, LED-935	Ø5" Ø127mm	29-3/4" 756mm	18" 457mm	26" 660mm	12" 305mm	6-5/8" 168mm	7" 178mm

Above measurements shown with 45° of adjustability. Certain driver options may alter housing dimensions. Contact factory for more details.

Modular Multiples®

The Original Multiple Light Family of Fixtures

Apertures®

Recessed - Trimless - New/Old Work



- Configurations:**
- 1, 2, 3, 4 light sources standard.
 - Rectangular, round, and square apertures standard.
 - Standard throat depth of 1-1/4" (32mm).
 - Customization available.

- Housing:**
- Fabricated 18 gauge steel housing connected to preformed panel with tape edge on all sides that mates to 5/8" (16mm) drywall or plaster.
 - Available for airtight or IC rated applications.

- Finishes:**
- Housing and ring sets powder coated – white or black standard.
 - Custom colors available.
 - Stainless steel / satin nickel available.
 - Panel provided with a white primer finish.

- Electrical:**
- One driver/transformer incorporated per light source for multi-circuit wiring.
 - Phase, 0-10V, DALI-2, and DMX dimming options available. Consult factory for available driver options.
 - 120/277V available.
 - Listed to UL1598 standards.

[Download CSI drop-in spec template](#)

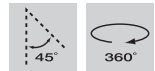

Light Sources: 579e LED Modules

LED-507-20	LED-712-20	LED-920-35
LED-507-30	LED-712-30	LED-920-45
LED-507-40	LED-712-40	LED-920-60
LED-508-20	LED-712-55	LED-920-90
LED-508-30	LED-714-20	LED-926-35
LED-508-40	LED-714-30	LED-926-45
LED-510-20	LED-714-40	LED-926-60
LED-510-30	LED-714-55	LED-926-90
LED-510-40	LED-716-20	LED-929-35
LED-511-20	LED-716-30	LED-929-45
LED-511-30	LED-716-40	LED-929-60
LED-511-40	LED-716-55	LED-929-90
LED-512-20	LED-720-20	LED-932-35
LED-512-30	LED-720-30	LED-932-45
LED-512-40	LED-720-40	LED-932-60
	LED-720-55	LED-932-90
		LED-935-35
		LED-935-45
		LED-935-60
		LED-935-90

LED legacy light source replacements:

MR16LED (-BLD)	PAR30LED (-GLD)
AR111LED (-DLD)	PAR38LED (-JLD)

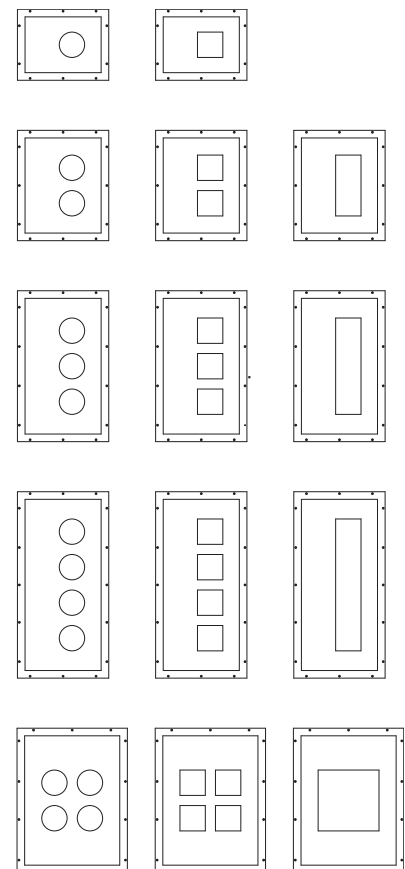

- Mounting:**
- Housings supported from above with 3/8" (9mm) all-thread rods.
 - Panels designed to be secured to ceiling framing structure via flat head screws through holes provided in tape edge.

- Options:**
- Patented aluminum ring sets and locking devices.
 - Pull down yokes.
 - Filter rings and shielding cylinders.
 - Filter media: up to two 1/8" (3mm) thick filter per light source.
 - Lutron Athena Wireless Node (white or black finish available).

Model # example:

MAS-3-LED-512-20-27-1-TI-RD-AWNR-WH-AT-IC

- Housing: airtight (AT), insulation contact rated (IC)
- Lutron Athena Wireless Node: White (-AWNR-WH), Black (AWNR-BL)
- Aperture: rectangular (REC), round (RD), square (SQ)
- Driver/transformer incorporated (TI), primary voltage (PV)
- Color: white (1), black (2), chrome (4), stainless steel (6), custom (x)
- Selected Kelvin temperature: 2700°K (27), 3000°K (30), 3500°K (35), 4000°K (40)
- Light sources: see above list
- Number of light sources
- Modular Multiples® Apertures® Series

Modular International, Inc.
1-412-734-9000
www.modularinternational.com

Modular Multiples®

The Original Multiple Light Family of Fixtures



579 Available LED Modules

Model Number	Watts	Beam Angle	CRI	Lumens	Lumens per watt
LED-507-20	7	20°	90+	798	114
LED-507-30	7	30°	90+	758	108
LED-507-40	7	40°	90+	761	109
LED-508-20	8	20°	90+	1,060	133
LED-508-30	8	30°	90+	988	124
LED-508-40	8	40°	90+	1,001	125
LED-510-20	10	20°	90+	1,245	125
LED-510-30	10	30°	90+	1,177	118
LED-510-40	10	40°	90+	1,189	119
LED-511-20	11	20°	90+	1,362	124
LED-511-30	11	30°	90+	1,289	117
LED-511-40	11	40°	90+	1,309	119
LED-512-20	12	20°	90+	1,458	122
LED-512-30	12	30°	90+	1,385	115
LED-512-40	12	40°	90+	1,407	117
LED-712-20	12	20°	90+	1,591	133
LED-712-30	12	30°	90+	1,580	132
LED-712-40	12	40°	90+	1,513	126
LED-712-55	12	55°	90+	1,557	130
LED-714-20	14	20°	90+	1,885	135
LED-714-30	14	30°	90+	1,858	133
LED-714-40	14	40°	90+	1,780	127
LED-714-55	14	55°	90+	1,834	131
LED-716-20	16	20°	90+	2,203	138
LED-716-30	16	30°	90+	2,174	136
LED-716-40	16	40°	90+	2,080	130
LED-716-55	16	55°	90+	2,149	134
LED-720-20	20	20°	90+	2,650	133
LED-720-30	20	30°	90+	2,583	129
LED-720-40	20	40°	90+	2,462	123
LED-720-55	20	55°	90+	2,554	128
LED-920-35	20	35°	90+	3,028	151
LED-920-45	20	45°	90+	2,993	150
LED-920-60	20	60°	90+	3,019	151
LED-920-90	20	90°	90+	3,112	156
LED-926-35	26	35°	90+	3,868	149
LED-926-45	26	45°	90+	3,813	147
LED-926-60	26	60°	90+	3,871	149
LED-926-90	26	90°	90+	3,985	153
LED-929-35	29	35°	90+	4,264	147
LED-929-45	29	45°	90+	4,190	144
LED-929-60	29	60°	90+	4,272	147
LED-929-90	29	90°	90+	4,406	152
LED-932-35	32	35°	90+	4,645	145
LED-932-45	32	45°	90+	4,575	143
LED-932-60	32	60°	90+	4,652	145
LED-932-90	32	90°	90+	4,819	151
LED-935-35	35	35°	90+	5,034	144
LED-935-45	35	45°	90+	4,986	142
LED-935-60	35	60°	90+	5,095	146
LED-935-90	35	90°	90+	5,224	149

Modular Multiples®

The Original Multiple Light Family of Fixtures

Fixture Options

Extendable Yokes

ADD -EY TO END OF MODEL NUMBER

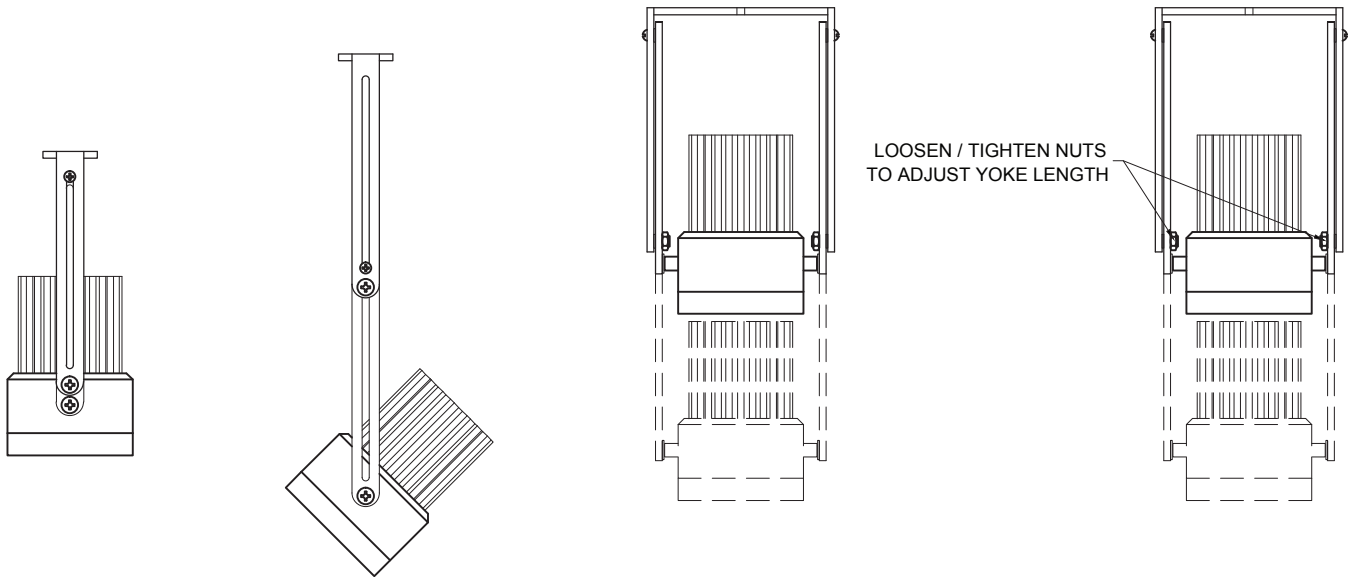

Shielding Options

ADD SHIELDING OPTION CODE (BELOW) TO END OF MODEL NUMBER

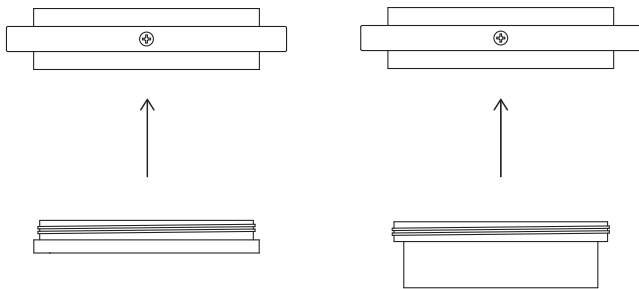

FILTER RING (STANDARD)

SHIELDING CYLINDER (-CY)

Lutron Athena Wireless Nodes

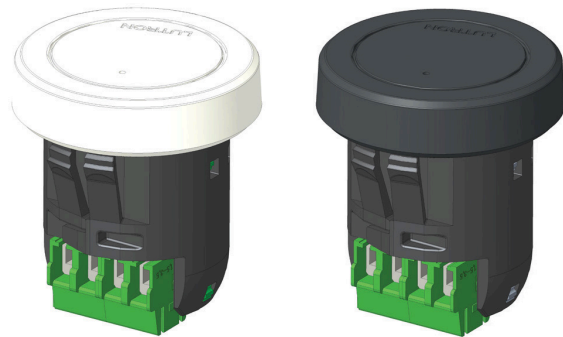

ATHENA WIRELESS NODE
WHITE (AWN-WH)

ATHENA WIRELESS NODE
BLACK (AWN-BL)

Filter Media

ADD FILTER MEDIA CODE (BELOW) TO END OF MODEL NUMBER

