

Modular Multiples®

1

Apertures®

Recessed - Trimless - New/Old Work

These elegant, trimless fixtures are thoroughly flexible in application. Apertures® preformed panels are easily grouped in linear or nonlinear patterns of any length or diameter, giving architects and designers the ability to create artful, imaginative, and seamless ceiling patterns. Round, square, and rectangular apertures with patented accessories such as locking rings and shielding filter media systems are standard. Custom configurations available. Fixture dimensions vary with lamp type.

Two Lamp Rectangular Aperture



MAS-2-B-x-TI-REC

Modular Multiples® Apertures® Series, two MR16 lamps, preformed panel, transformer incorporated, rectangular aperture. Other configurations available.

[Download CSI drop-in spec template](#)

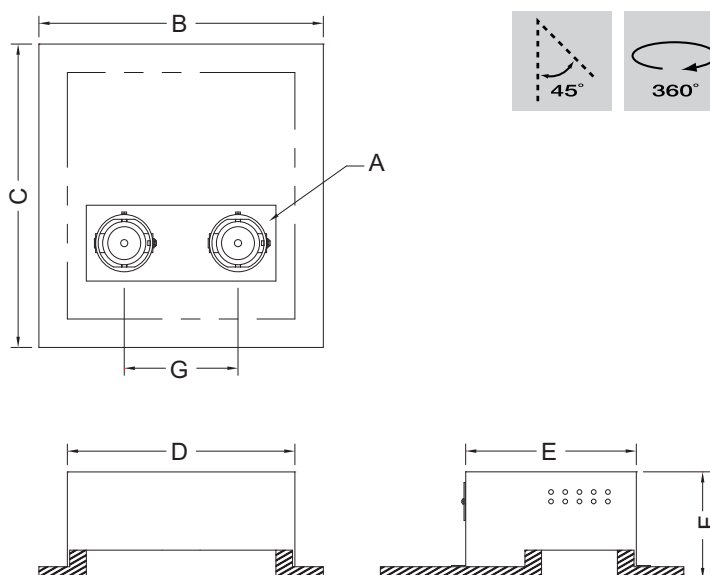

LAMPS and DIMENSIONS	A	B	C	D	E	F	G
LED506, 513 MR16LED / MR16	4" x 10" 102 x 254mm	15" 381mm	16" 406mm	12" 305mm	9" 229mm	5-5/8" 143mm	6" 152mm
LED708, 714, 716, 930 AR111LED / AR111	7" x 17-1/2" 179 x 445mm	22-1/2" 572mm	16" 406mm	19-1/2" 495mm	11" 279mm	5-5/8" 143mm	10-1/2" 267mm
PAR38LED / PAR38	7-1/2" x 18-3/4" 191 x 476mm	23-3/4" 603mm	18" 457mm	20-3/4" 527mm	13" 330mm	9" 229mm	11-1/4" 286mm

Modular Multiples®

The Original Multiple Lamp Family of Fixtures

1

Apertures®

Recessed - Trimless - New/Old Work



Patented

- Configurations:**
- 1, 2, 3, 4 light units standard
 - Round, square, rectangular apertures, with a standard throat depth of 1-1/2"
 - Customization available

Housing: Fabricated 18 gauge steel housing connected to preformed panel with tape edge on all sides that mates to 5/8" drywall or plaster

[Download CSI drop-in spec template](#)

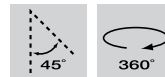

- Finishes:**
- Housing and ring sets powder coated - white or black standard
 - Custom colors available
 - Stainless steel / satin nickel available
 - Panel provided with a white primer finish

- Electrical:**
- Internal electronic power supply(s) / transformer(s) / ballast(s) accessible through the aperture of the fixture
 - Dimmable (not applicable on HID products)
 - One power supply/transformer per lamp for multi-circuit wiring
 - 120v and 277v available
 - Listed to UL1598 standards

Lamping:

Standard LED Modules

6w LED-506-6	12w LED-512-12	12w LED-512-22
8w LED-708-6	14w LED-714-12	14w LED-714-22
16w LED-716-12	16w LED-716-22	16w LED-716-45
30w LED-930-12	30w LED-930-22	30w LED-930-45

Direct Replacement LED or Legacy Lamps:

MR16LED (BLD)	MR16 HALOGEN (B)	MR16CMH (BH)
AR111LED (DLD)	AR111 HALOGEN (D)	CDMR111 (S)
PAR30LED (GLD)	PAR30 (G)	PAR30HID (H)
PAR38LED (JLD)	PAR38 (J)	PAR38HID (K)

- Mounting:**
- Housings designed to be supported from above with 3/8" (9mm) all-thread rods
 - Panels designed to be secured to ceiling framing structure via flat head screws through holes provided in tape edge

- Options:**
- Patented die-cast aluminum ring sets and locking devices
 - Pull down yokes
 - Shielding cones
 - Filter media
 - LED modules accept one 1/8" thick filter
 - LED direct replacement and legacy lamps accept up to two 1/8" thick filters

Model # example:

MAS-3-D-x-TI-RD-xx

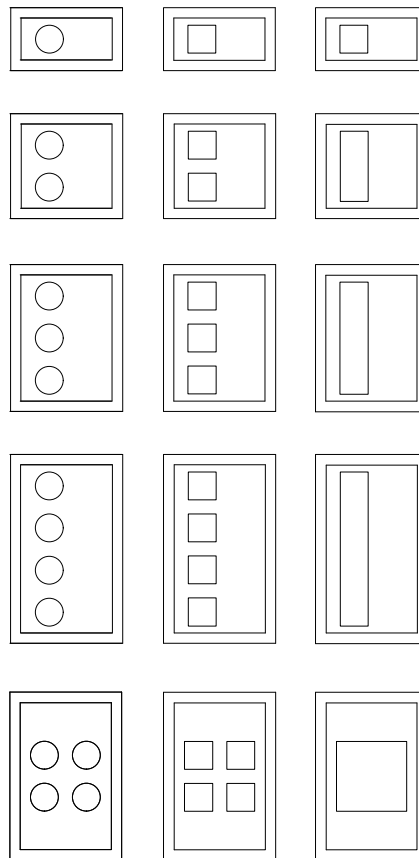
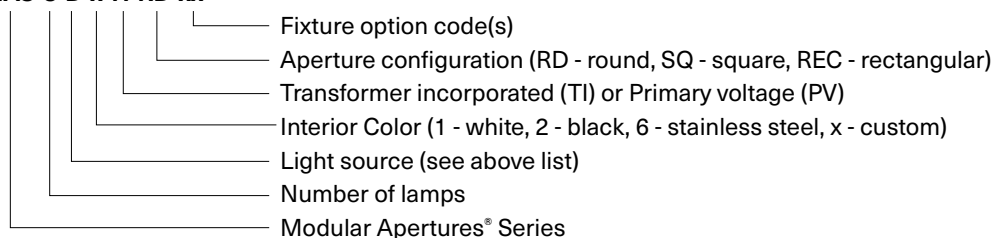

Modular Multiples®

The Original Multiple Lamp Family of Fixtures

1

Apertures®

Recessed - Trimless - New/Old Work

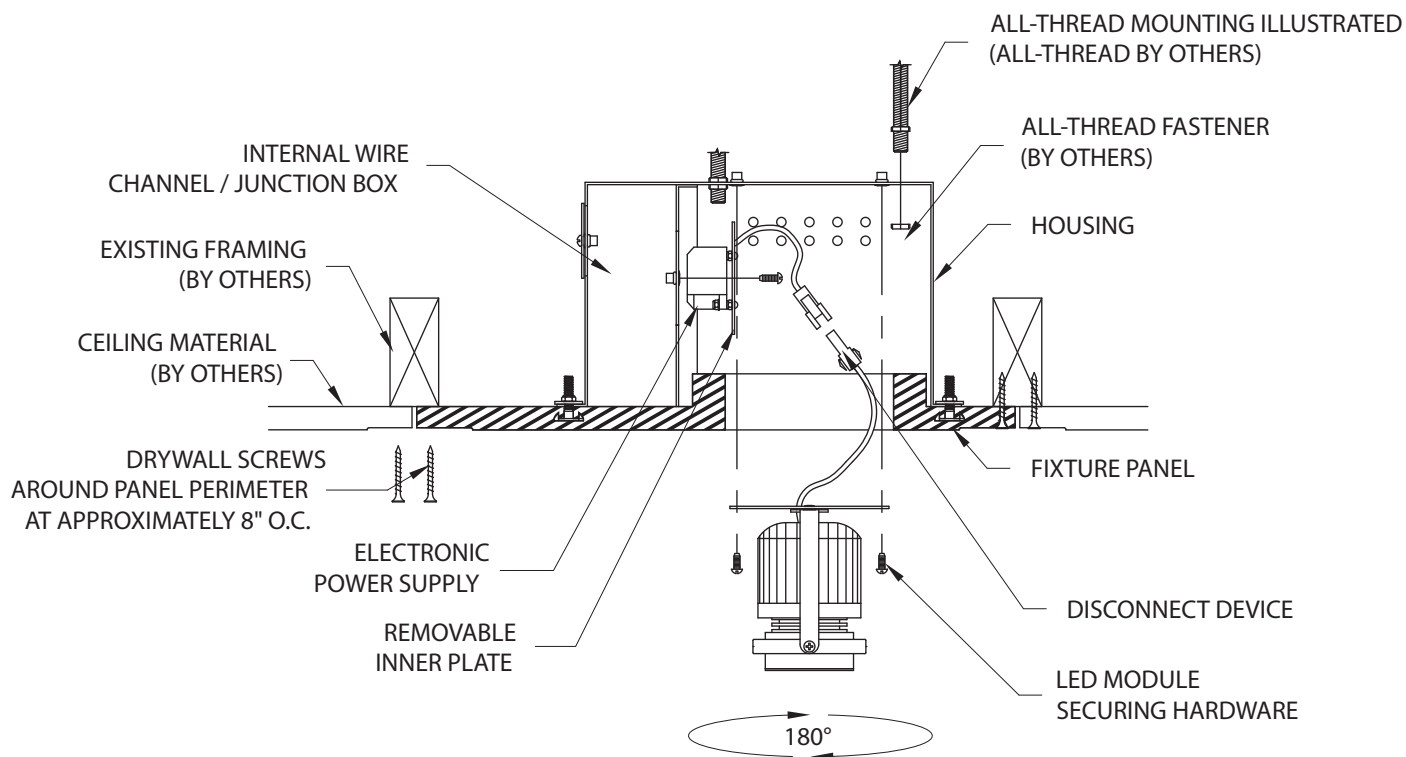

END SECTION

Modular Multiples®

The Original Multiple Lamp Family of Fixtures



Standard LED Modules

LED-506-6

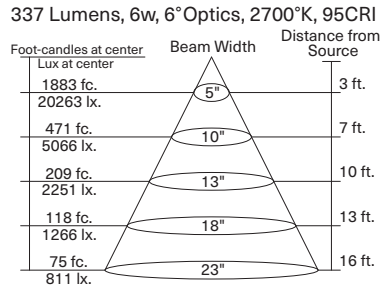

LED-512-12

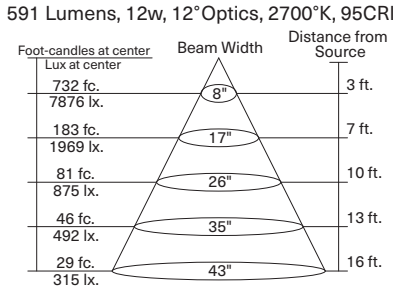

LED-512-22

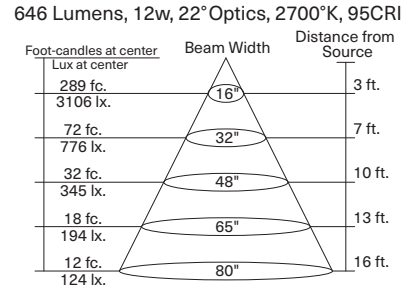

LED-708-6

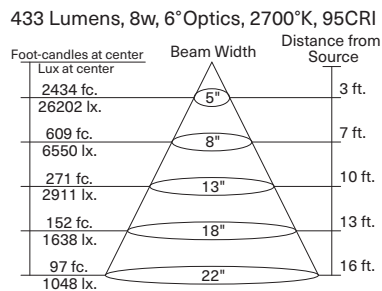

LED-714-12

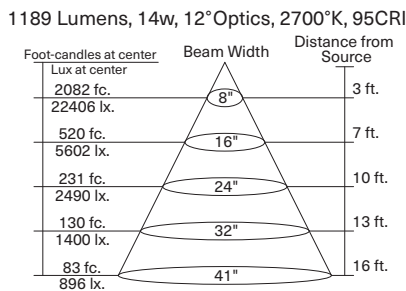

LED-714-22

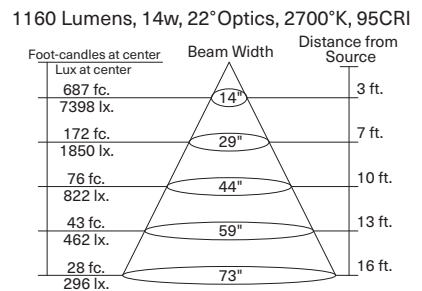

LED-716-12

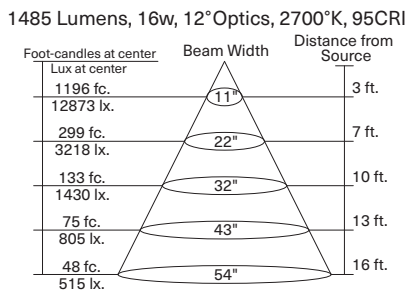

LED-716-22

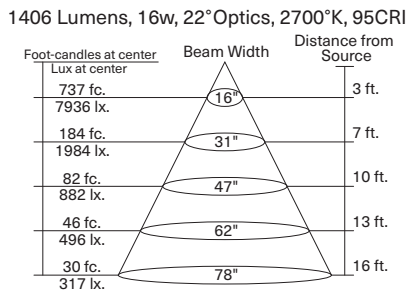

LED-716-45

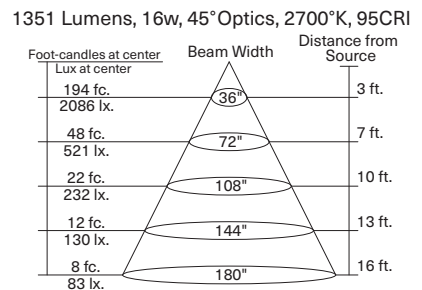

LED-930-12

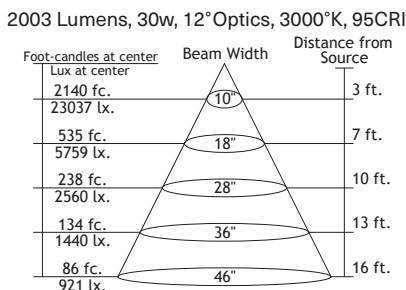

LED-930-22

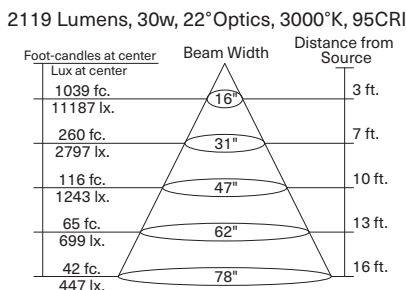

LED-930-45

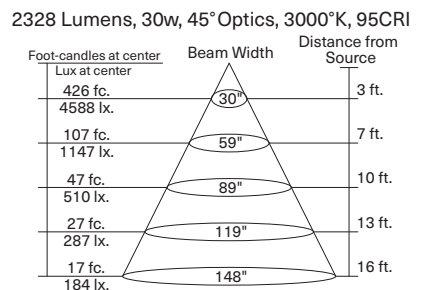

Modular Multiples®

The Original Multiple Lamp Family of Fixtures

Fixture Options

Modular accessories are used individually or in inventive combinations to shield brightness, reduce glare, vary beam patterns, retain direction, and alter color. Dimensions of all fixture options vary with lamp size.

Ring Sets and Locking Devices (PATENTED)

ADD -LM TO END OF MODEL NUMBER

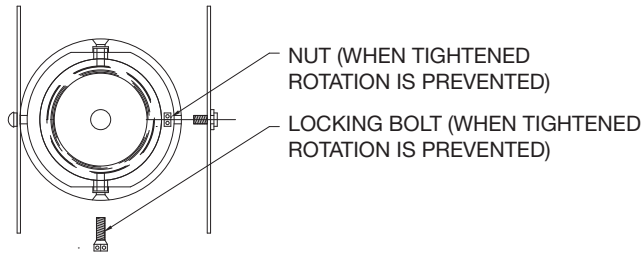

BOTTOM VIEW

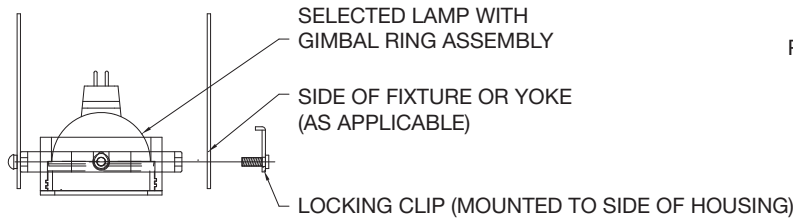

FRONT VIEW

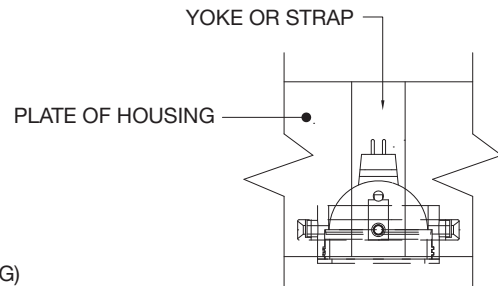

SIDE VIEW

Extendable Yokes

ADD -EY TO END OF MODEL NUMBER

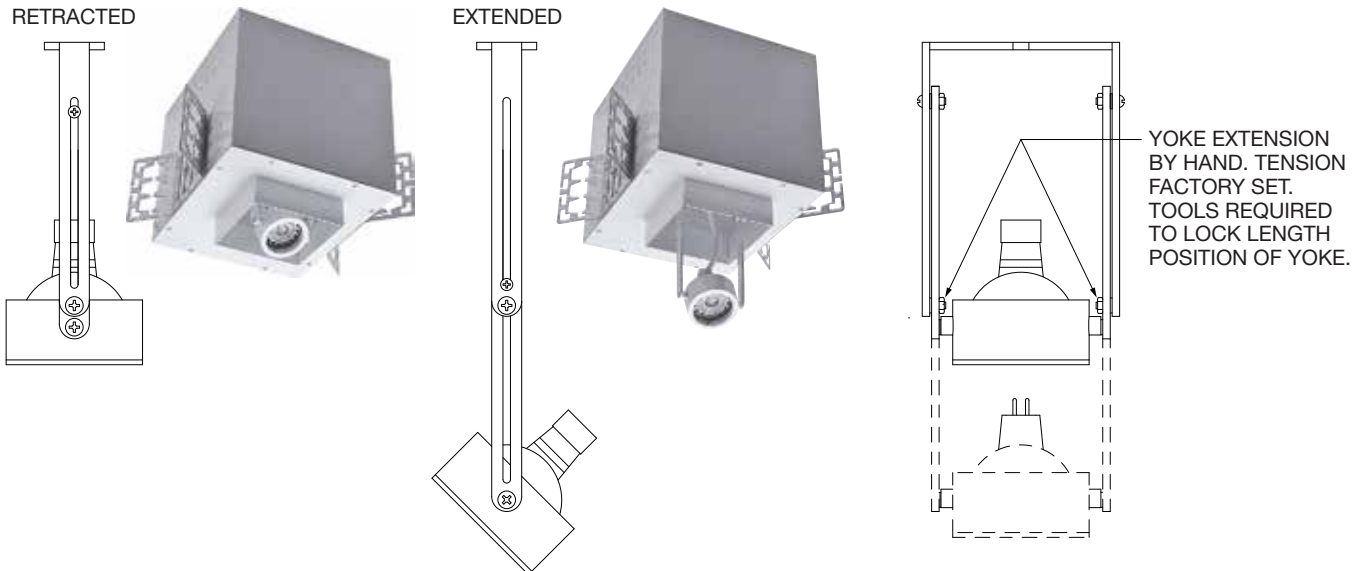

Modular Multiples®

The Original Multiple Lamp Family of Fixtures

Fixture Options

Modular accessories are used individually or in inventive combinations to shield brightness, reduce glare, vary beam patterns, retain direction, and alter color. Fixture option dimensions vary with lamp size.

Shielding Options

ADD SHEILDING OPTION CODE (BELOW) TO END OF MODEL NUMBER

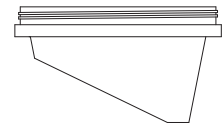
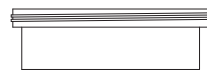
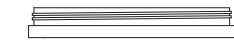
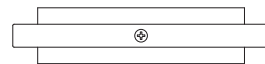
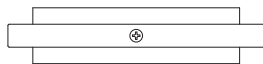

FILTER RING (STANDARD)

SHIELDING CONE (-SC)

SHIELDING CYLINDER (-CY)

WALL WASH CONE (-WWC)

Filter Media

ADD FILTER MEDIA CODE (BELOW) TO END OF MODEL NUMBER

LED modules accept one 1/8" thick filter. LED direct replacement and legacy lamps accept up to two 1/8" thick filters.

CLEAR GLASS (-CG)

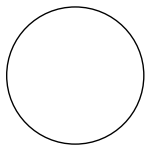

DIFFUSING SPREAD (-DS)

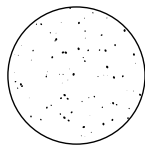

CUBE CELL LOUVER (-CL)

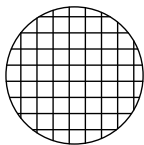

HEXCELL LOUVER (-HL)

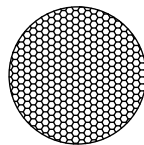

LINEAR SPREAD (-LS)

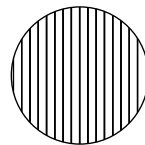

PRISMATIC WIDE SPREAD (-PS)

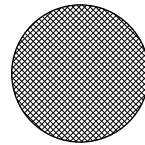

SATIN ETCHED (-SE)

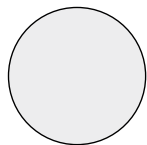

UV BLOCKING (-UB)

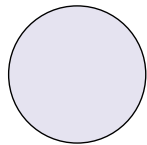

DICHROIC

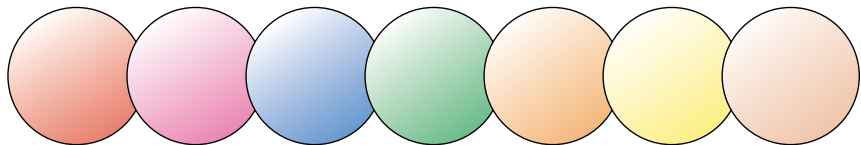

RED (-DR)

MAGENTA (-DM)

BLUE (-DB)

GREEN (-DG)

AMBER (-DA)

YELLOW (-DY)

PEACH (-DP)