

# Modular Multiples®

1

## Apertures®

Recessed - Trimless - New/Old Work

These elegant, trimless fixtures are thoroughly flexible in application. Apertures® preformed panels are easily grouped in linear or nonlinear patterns of any length or diameter, giving architects and designers the ability to create artful, imaginative, and seamless ceiling patterns. Round, square, and rectangular apertures with patented accessories such as locking rings and shielding filter media systems are standard. Custom configurations available. Fixture dimensions vary with lamp type.

### Custom Rotation One Square Aperture

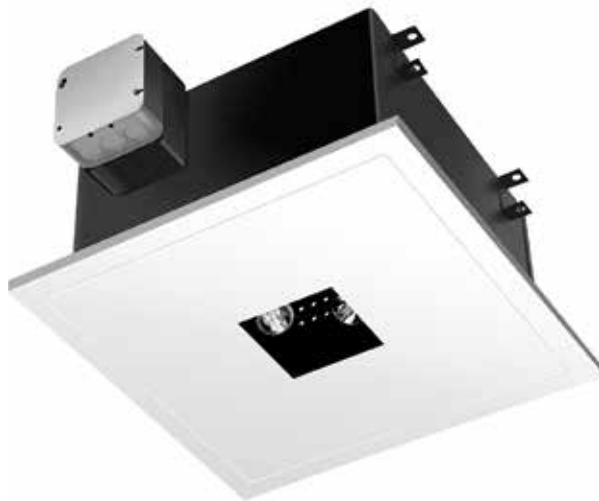

MRF-4-B-1-TI-SQ-TL

Modular Apertures Series, custom, four MR16 legacy lamps, 6" square aperture, transformer incorporated configuration shown. Other configurations available.

Other configurations available.

[Download CSI drop-in spec template](#)

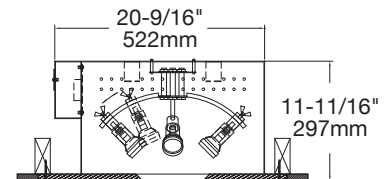
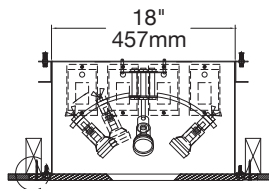
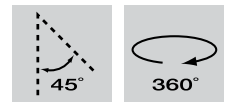
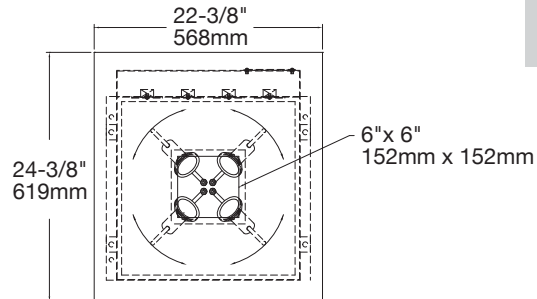

# Modular Multiples®

The Original Multiple Lamp Family of Fixtures

1

## Apertures®

Recessed - Trimless - New/Old Work



- Configurations:**
- 1, 2, 3, 4 light units standard
  - Round, square, rectangular apertures, with a standard throat depth of 1-1/2"
  - Customization available

**Housing:** Fabricated 18 gauge steel housing connected to preformed panel with tape edge on all sides that mates to 5/8" drywall or plaster

[Download CSI drop-in spec template](#)

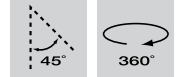

- Finishes:**
- Housing and ring sets powder coated - white or black standard
  - Custom colors available
  - Stainless steel / satin nickel available
  - Panel provided with a white primer finish

- Electrical:**
- Internal electronic power supply(s) / transformer(s) / ballast(s) accessible through the aperture of the fixture
  - Dimmable (not applicable on HID products)
  - One power supply/transformer per lamp for multi-circuit wiring
  - 120v and 277v available
  - Listed to UL1598 standards

**Lamping:**

**Standard LED Modules**

6w LED-506-6	12w LED-512-12	12w LED-512-22
8w LED-708-6	14w LED-714-12	14w LED-714-22
16w LED-716-12	16w LED-716-22	16w LED-716-45
30w LED-930-12	30w LED-930-22	30w LED-930-45

**Direct Replacement LED or Legacy Lamps:**

MR16LED (BLD)	MR16 HALOGEN (B)	MR16CMH (BH)
AR111LED (DLD)	AR111 HALOGEN (D)	CDMR111 (S)
PAR30LED (GLD)	PAR30 (G)	PAR30HID (H)
PAR38LED (JLD)	PAR38 (J)	PAR38HID (K)

- Mounting:**
- Housings designed to be supported from above with 3/8" (9mm) all-thread rods
  - Panels designed to be secured to ceiling framing structure via flat head screws through holes provided in tape edge

- Options:**
- Patented die-cast aluminum ring sets and locking devices
  - Pull down yokes
  - Shielding cones
  - Filter media
    - LED modules accept one 1/8" thick filter
    - LED direct replacement and legacy lamps accept up to two 1/8" thick filters

**Model # example:**

**MAS-3-D-x-TI-RD-xx**

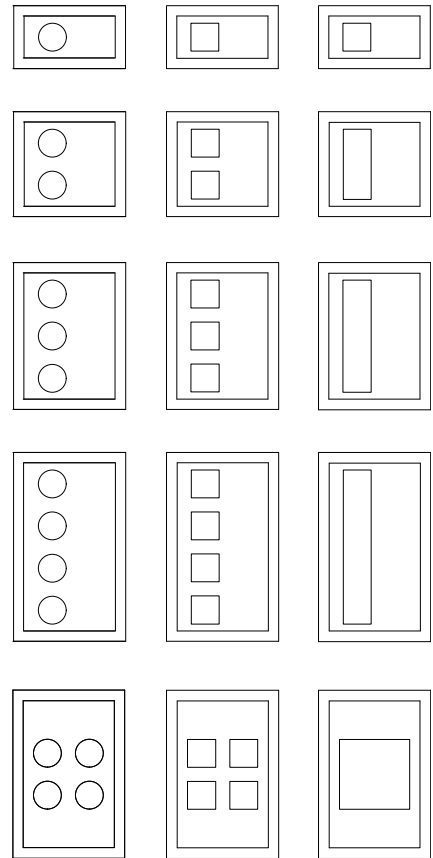
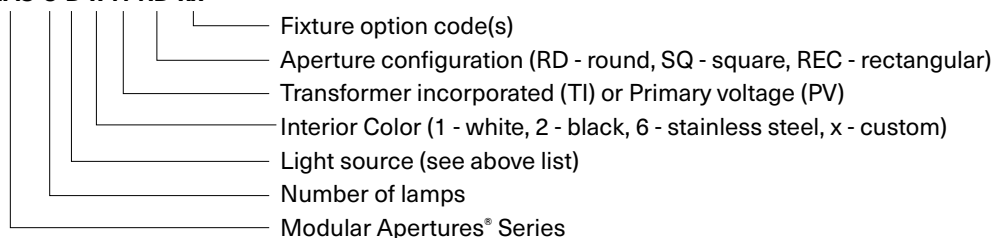

# Modular Multiples®

The Original Multiple Lamp Family of Fixtures

1

## Apertures®

Recessed - Trimless - New/Old Work

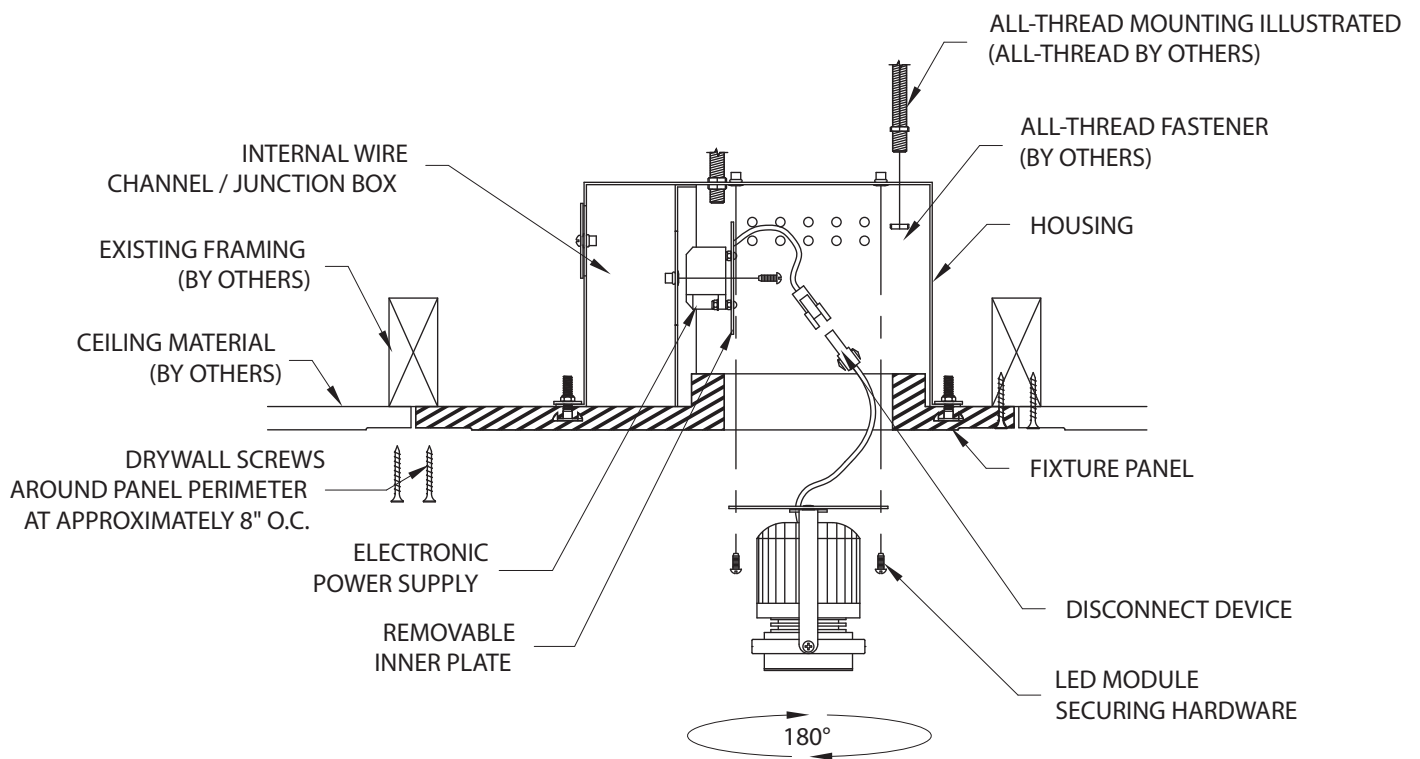

END SECTION

# Modular Multiples®

The Original Multiple Lamp Family of Fixtures



## Standard LED Modules

### LED-506-6

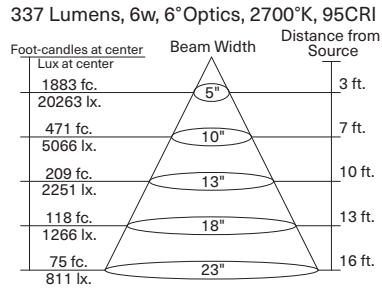

### LED-512-12

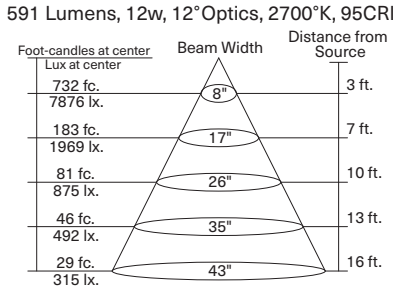

### LED-512-22

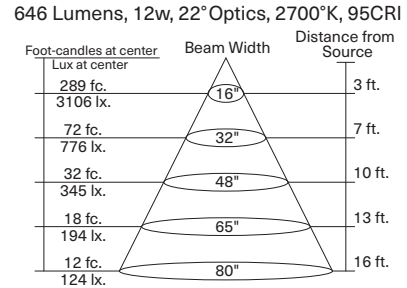

### LED-708-6

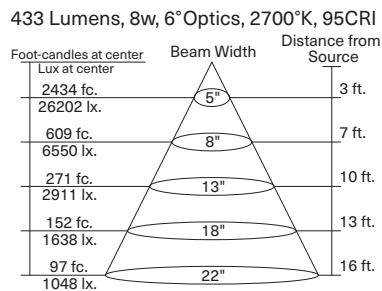

### LED-714-12

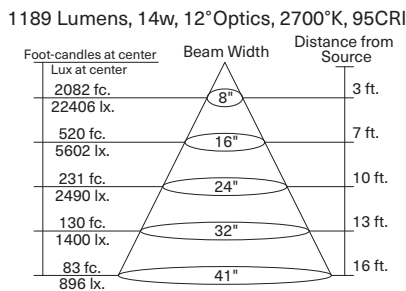

### LED-714-22

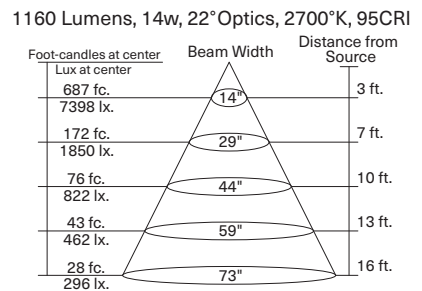

### LED-716-12

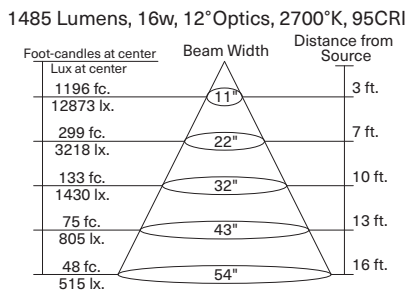

### LED-716-22

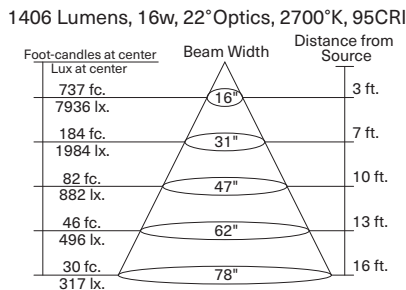

### LED-716-45

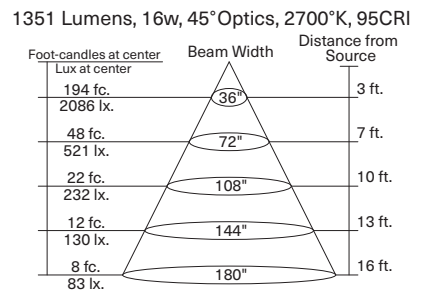

### LED-930-12

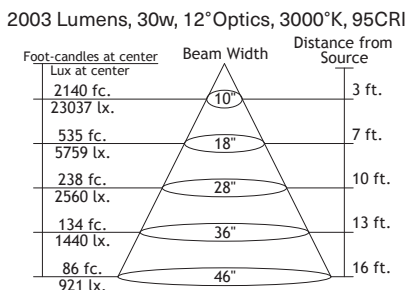

### LED-930-22

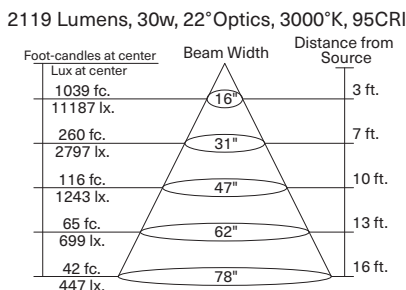

### LED-930-45

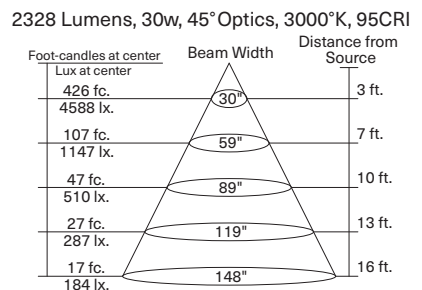

# Modular Multiples®

The Original Multiple Lamp Family of Fixtures

## Fixture Options

Modular accessories are used individually or in inventive combinations to shield brightness, reduce glare, vary beam patterns, retain direction, and alter color. Dimensions of all fixture options vary with lamp size.

### Ring Sets and Locking Devices (PATENTED)

ADD -LM TO END OF MODEL NUMBER

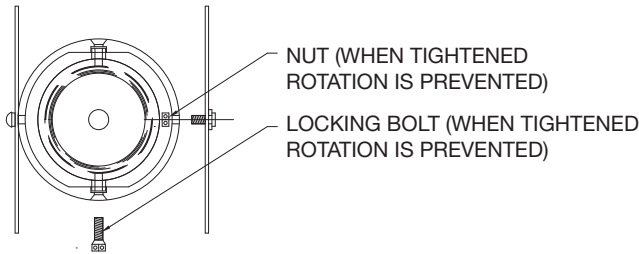

**BOTTOM VIEW**

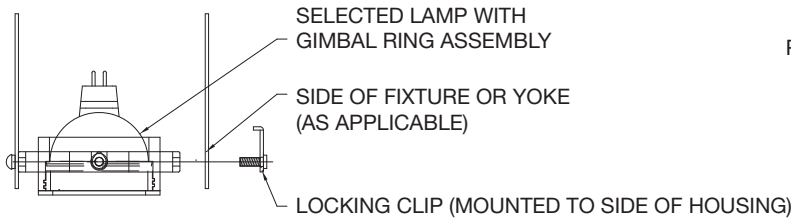

**FRONT VIEW**

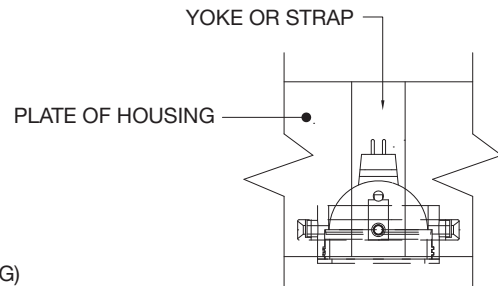

**SIDE VIEW**

### Extendable Yokes

ADD -EY TO END OF MODEL NUMBER

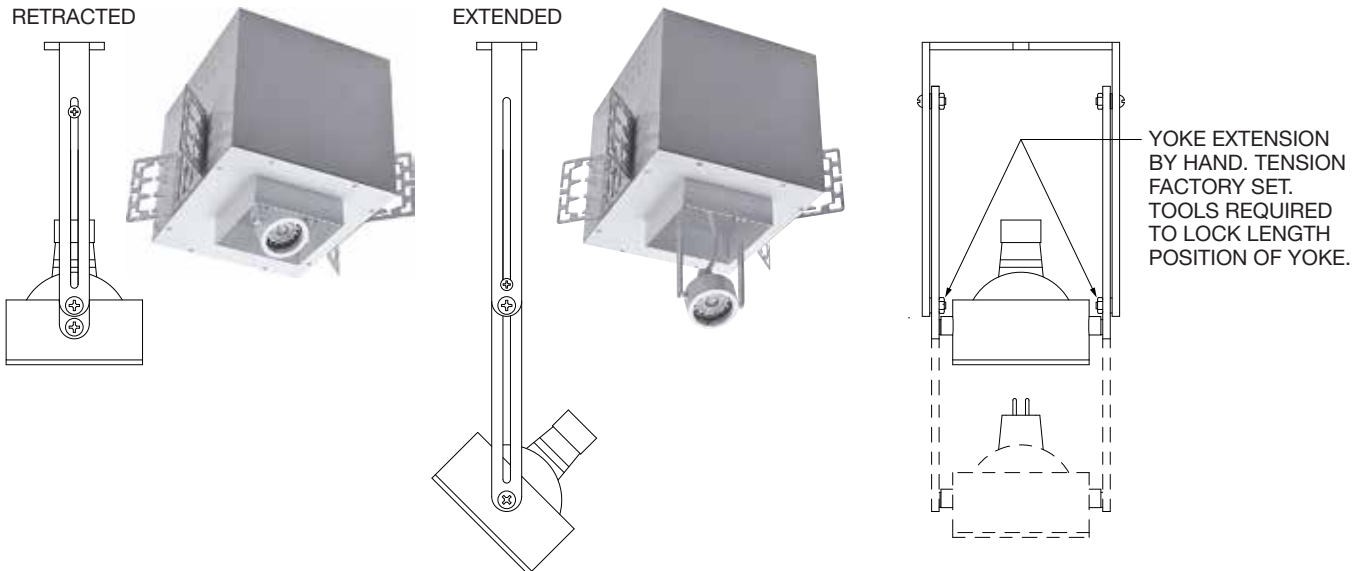

# Modular Multiples®

The Original Multiple Lamp Family of Fixtures

## Fixture Options

Modular accessories are used individually or in inventive combinations to shield brightness, reduce glare, vary beam patterns, retain direction, and alter color. Fixture option dimensions vary with lamp size.

### Shielding Options

ADD SHEILDING OPTION CODE (BELOW) TO END OF MODEL NUMBER

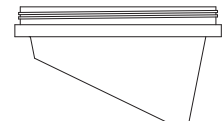
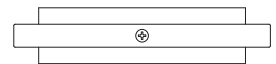
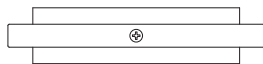

FILTER RING (STANDARD)

SHIELDING CONE (-SC)

SHIELDING CYLINDER (-CY)

WALL WASH CONE (-WWC)

### Filter Media

ADD FILTER MEDIA CODE (BELOW) TO END OF MODEL NUMBER

LED modules accept one 1/8" thick filter. LED direct replacement and legacy lamps accept up to two 1/8" thick filters.

CLEAR GLASS (-CG)

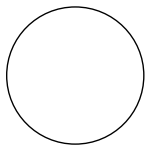

DIFFUSING SPREAD (-DS)

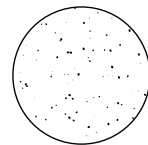

CUBE CELL LOUVER (-CL)

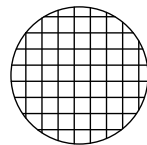

HEXCELL LOUVER (-HL)

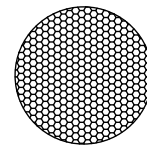

LINEAR SPREAD (-LS)

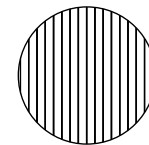

PRISMATIC WIDE SPREAD (-PS)

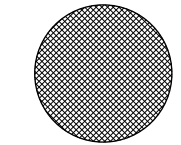

SATIN ETCHED (-SE)

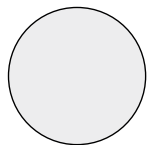

UV BLOCKING (-UB)

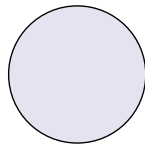

DICHROIC

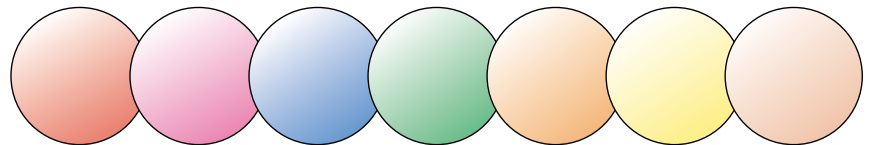

RED (-DR)

MAGENTA (-DM)

BLUE (-DB)

GREEN (-DG)

AMBER (-DA)

YELLOW (-DY)

PEACH (-DP)