

Modular Multiples®

The Original Multiple Light Family of Fixtures

Boomerang

Surface Mounted - New/Old Work

Contemporary fixtures for unique installations. Superior design, materials, manufacture, and customization make Boomerang fixtures high tech and high performance.

One Light (16w)

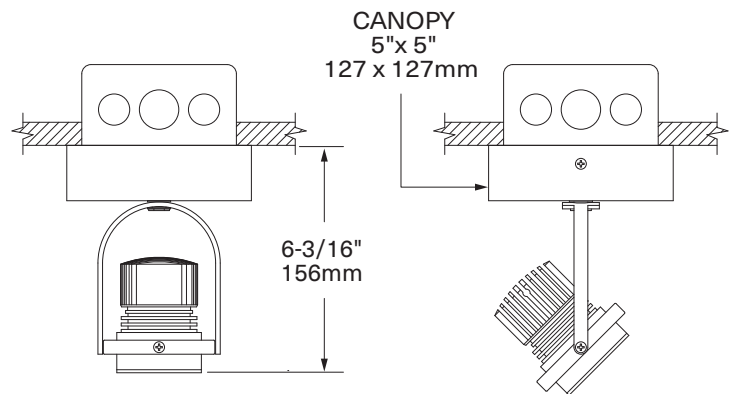
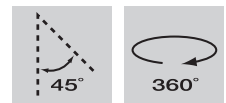
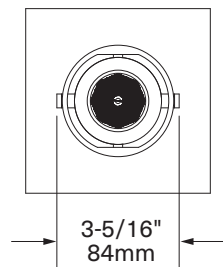

MBS-1-LED-516-14-30-6-TI-S-AWNR-WH

Modular Multiples® Boomerang Series, one 16w Element™

LED module, 3000°K, aluminum and stainless steel,
driver/transformer incorporated, surface canopy,

Lutron Athena Wireless Node-white configuration shown.

Other configurations available.

[Download CSI drop-in spec template](#)

Modular Multiples®

The Original Multiple Light Family of Fixtures

Boomerang

Surface Mounted - New/Old Work



Configurations: • 1, 2, 4 light sources standard.

Housing:

- Extruded and machined aluminum body.
- 16 gauge stainless steel canopy.

Finishes:

- Stainless steel/satin nickel rings and canopy.
- Silver powder coated accent pieces standard.
- Powder coated custom colors available.

Electrical:

- One driver/transformer incorporated per light source for multi-circuit wiring.
- Phase, 0-10V, DALI-2, and DMX dimming options available. Consult factory for driver options.
- 120/277V available.
- Listed to UL1598 standards.

Light Sources: Elements™ LED Modules

16w LED-516-14	16w LED-516-21	16w LED-516-34
30w LED-530-14	30w LED-530-21	30w LED-530-34

Mounting: • Recessed or surface mounted canopies available

Options:

- Patented aluminum ring sets and locking devices.
- Filter rings and shielding cylinders.
- Filter media: one 1/8" (3mm) thick filter per light source.
- Lutron Athena Wireless Node – white or black finish available.

Model # example: MBS-1-LED-516-14-30-6-TI-S-AWNR-WH

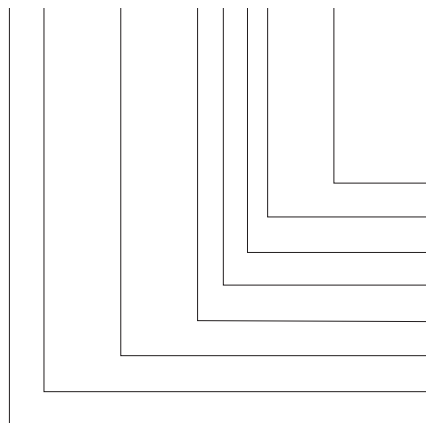

Lutron Athena Wireless Node: White (-AWNR-WH), Black (AWNR-BL)
Canopy: Recessed (R) or surface (S)
Driver/transformer incorporated (TI), Primary voltage (PV)
Color: white (1), black (2), stainless steel (6), custom (x)
Selected kelvin temperature: 2850°K (28), 3000°K (30)
Light sources: see above list
Number of light sources
Modular Multiples® Boomerang Series

[Download CSI drop-in spec template](#)

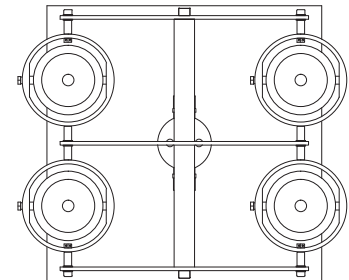
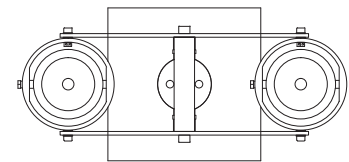
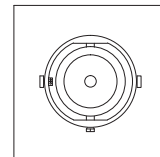

Modular International, Inc.



Elements™ 16w LED Module

16_w

Model : LED-516

Wattage: 16

Lumens: 640 at 3000°K

Kelvin Temperature: 2850°K or 3000°K (+/- 2%)

Standard CRI: 95

Accessories and customization available: Tuning, dimming, beam angles, Kelvin temperature, shielding and filtering

Beam Angles: 14° Spot, 21° Narrow Flood, 34° Flood, 6° beam angle also available

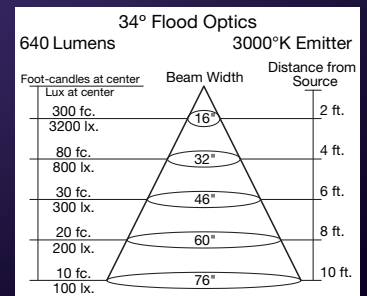
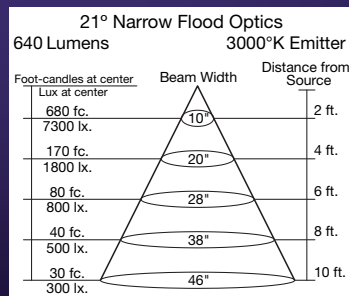
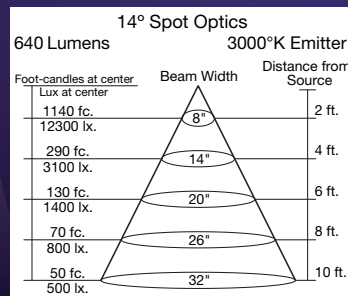

Elements™ 30w LED Module

30_w

Model : LED-530

Wattage: 30

Lumens: 1200 at 3000°K

Kelvin Temperature: 2850°K or 3000°K (+/- 2%)

Standard CRI: 95

Accessories and customization available: Tuning, dimming, beam angles, Kelvin temperature, shielding and filtering

Beam Angles: 14° Spot, 21° Narrow Flood, 34° Flood, 6° beam angle also available

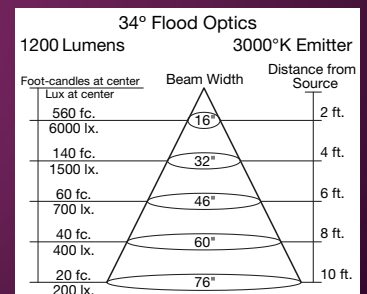
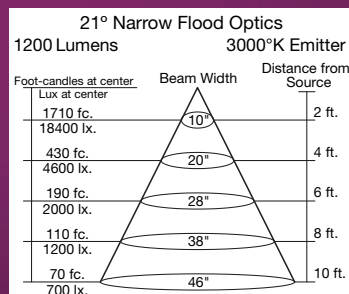
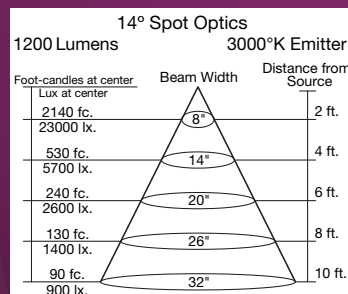

Modular Multiples®

The Original Multiple Light Family of Fixtures

Fixture Options

Extendable Yokes

ADD -EY TO END OF MODEL NUMBER

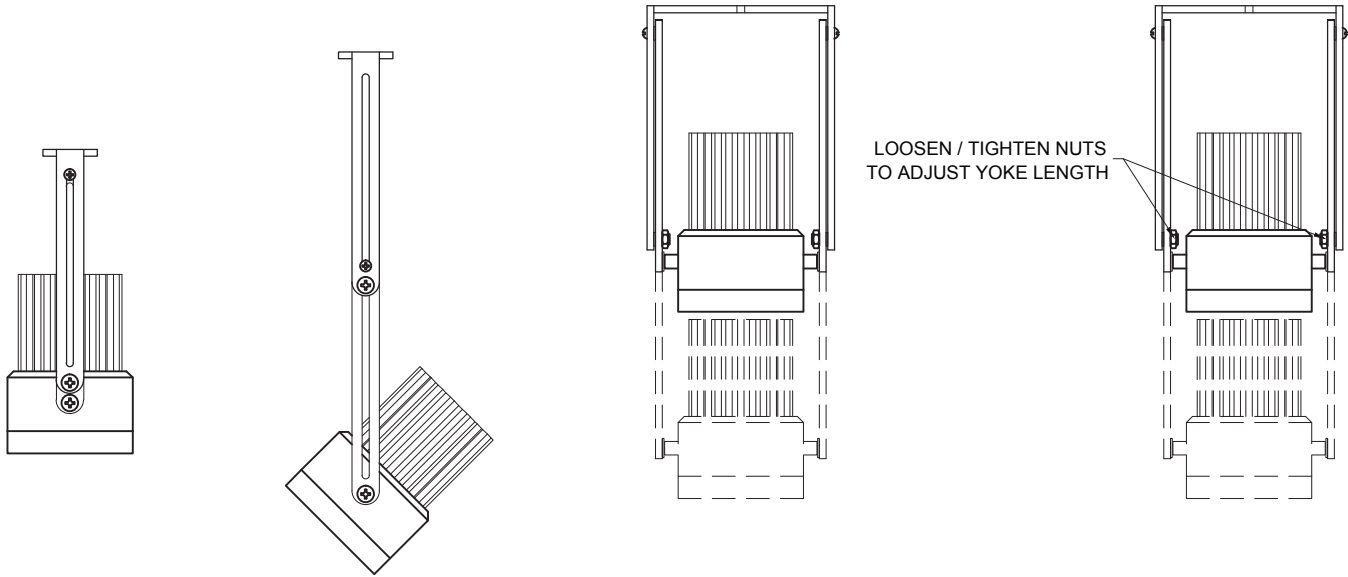

Shielding Options

ADD SHIELDING OPTION CODE (BELOW) TO END OF MODEL NUMBER



FILTER RING (STANDARD)

SHIELDING CYLINDER (-CY)

Lutron Athena Wireless Nodes



ATHENA WIRELESS NODE
WHITE (AWN-WH)

ATHENA WIRELESS NODE
BLACK (AWN-BL)

Filter Media

ADD FILTER MEDIA CODE (BELOW) TO END OF MODEL NUMBER

