

# Modular Multiples®

## Linears®

Recessed/Surface - Trimless/Trimmed - New/Old Work

Built to your specifications, these extruded housings enable unbroken fixture lengths up to 10 feet (3 meters). Lamp size determines minimum width; maximum width is unrestricted with housing connection hardware. Articulated arms (optional) increase flexibility of orientation or hide lamp source. May be ordered trimmed or trimless, in symmetric and asymmetric configurations. Uses all LED and legacy lamp sources. (patent #6,234,644)

### Linears® Recessed Trimless Five Mixed Lamp

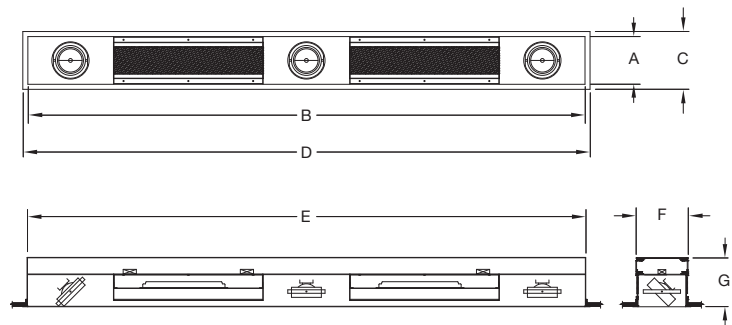

ML-3-DLD/2-LED-TI-REC-TL

Modular Multiples® Linears® Series, three AR111 LED lamps and two linear LED modules, recessed extruded aluminum housing with black exterior and white interior, driver/transformer incorporated, rectangular aperture, trimless configuration shown. Other configurations available. (patent #6,234,644)

[Download CSI drop-in spec template](#)

LAMPS and DIMENSIONS	A	B	C	D	E	F	G
LED708, 714, 716, 930	7-11/16"	89-3/4"	9-5/16"	91-3/8"	90"	8-7/16"	7-7/8"
AR111LED / AR111 / LINEAR LED	195mm	2280mm	252mm	2321mm	2286mm	214mm	200mm

# Modular Multiples®

The Original Multiple Lamp Family of Fixtures



## Linears®

Recessed - Trimless/Trimmed - New/Old Work



- Configurations:**
- Lamps spaced 6" on center or greater
  - Lamp size determines minimum width, maximum width is unrestricted
  - Articulated arms (optional) increase flexibility of orientation or hide lamp source
  - Available in symmetric and asymmetric configurations
  - Uses all LED modules and legacy lamp sources

- Housing:**
- Extruded aluminum profile with a series of internal steel plates – single lengths up to 10'
  - Connection hardware available for joining multiple pieces to make longer continual lengths
  - Available with extruded aluminum trim or trimless housing with spackle flange
  - 90° and 45° corner sections available

- Finishes:**
- Powder coated: white or black standard, custom colors available
  - Stainless steel / satin nickel available

- Electrical:**
- Internal electronic power supply(s) / transformer(s) / ballast(s) accessible through the aperture of the fixture
  - Dimmable (not applicable on HID products)
  - One power supply / transformer per lamp allowing for multi-circuit wiring
  - 120v and 277v available
  - Listed to UL1598 standards

**Lamping:**

**Standard LED Modules**

6w LED-506-6	12w LED-512-12	12w LED-512-22
8w LED-708-6	14w LED-714-12	14w LED-714-22
16w LED-716-12	16w LED-716-22	16w LED-716-45
30w LED-930-12	30w LED-930-22	30w LED-930-45

**Direct Replacement LED or Legacy Lamps:**

MR16LED (BLD)	MR16 HALOGEN (B)	MR16CMH (BH)
AR111LED (DLD)	AR111 HALOGEN (D)	CDMR111 (S)
PAR30LED (GLD)	PAR30 (G)	PAR30HID (H)
PAR38LED (JLD)	PAR38 (J)	PAR38HID (K)

**Mounting:**

- Fixture is designed to be supported from above with 3/8" (9mm) all-thread rods.
- Access plates for all thread attachment are positioned throughout the fixture body based on fixture length and lamp spacing allowing for access from below.
- In addition to the all thread rods, the Trimless models have a spackle flange that will allow for fixture to be secured to surrounding ceiling or wall structure via screws and flange covered with spackling compound for a smooth finished appearance.

**Options:**

- Patented die-cast aluminum ring sets and locking devices
- Pull down yokes
- Shielding cones
- Filter media
  - LED modules accept one 1/8" thick filter
  - LED direct replacement and legacy lamps accept up to two 1/8" thick filters

**Model # example:**

**ML-2-LED/30-x-TI-REC-TR-(length)**

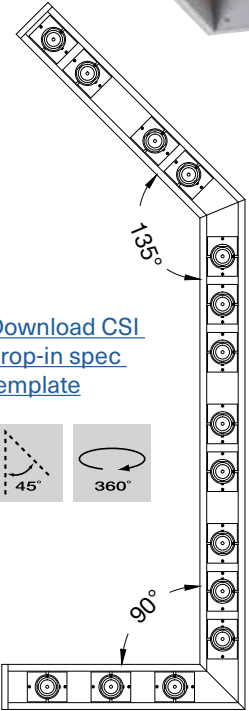
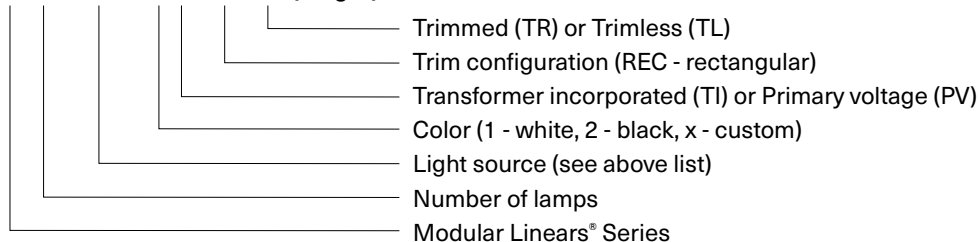

[Download CSI drop-in spec template](#)

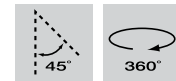

# Modular Multiples®

## Linears® Typical Installation

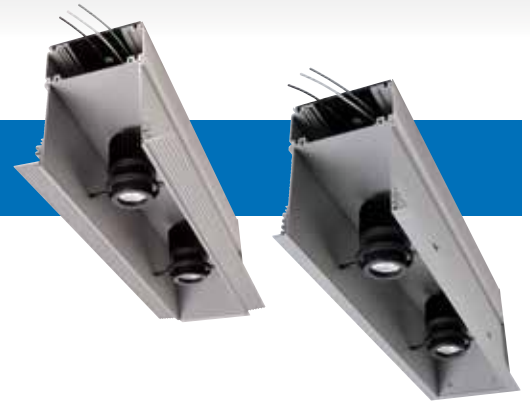

TYPICAL TRIMLESS INSTALLATION

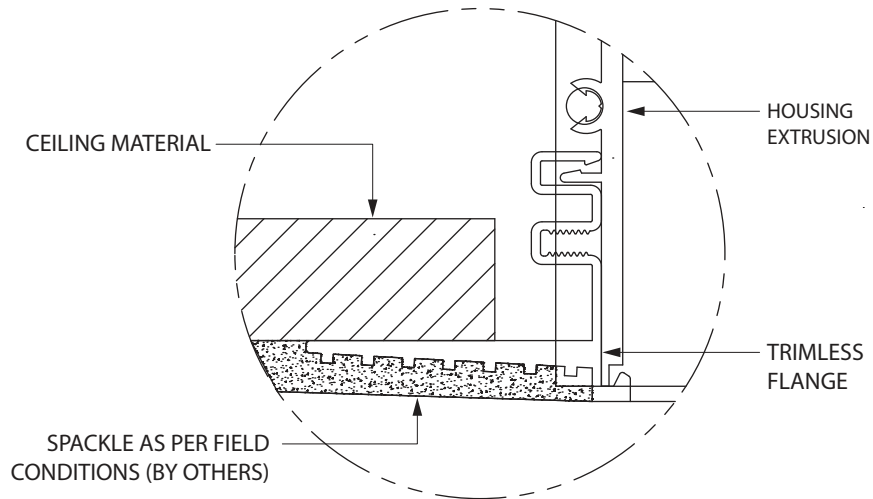

FIXTURE IS DESIGNED TO BE SUPPORTED FROM ABOVE WITH 3/8" (9MM) ALL-THREAD RODS

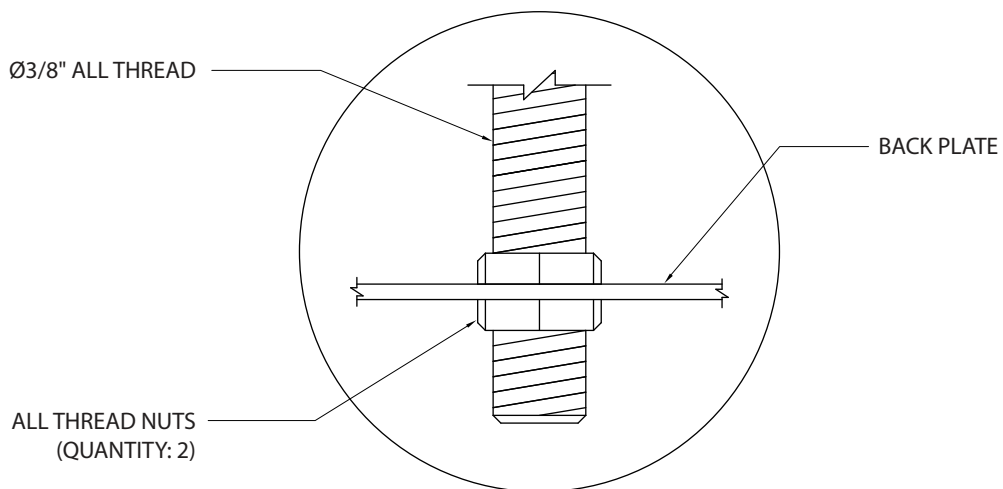

# Modular Multiples®

The Original Multiple Lamp Family of Fixtures



## Standard LED Modules

### LED-506-6

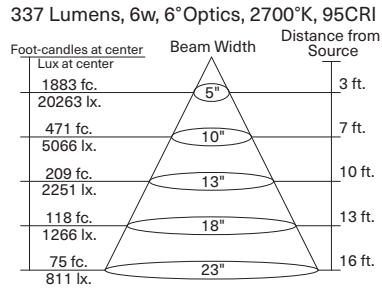

### LED-512-12

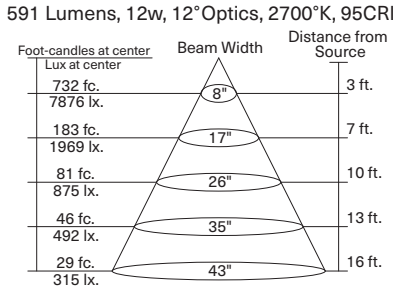

### LED-512-22

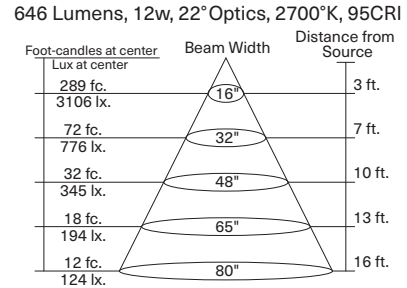

### LED-708-6

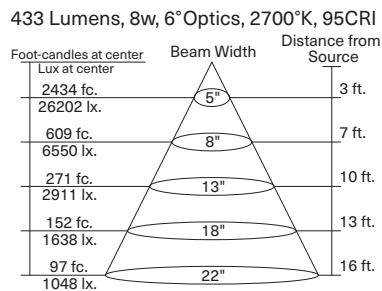

### LED-714-12

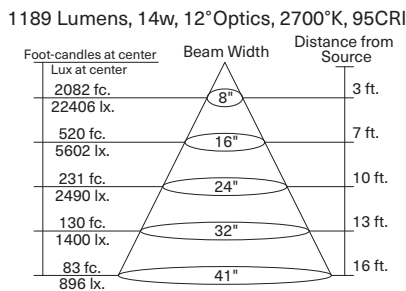

### LED-714-22

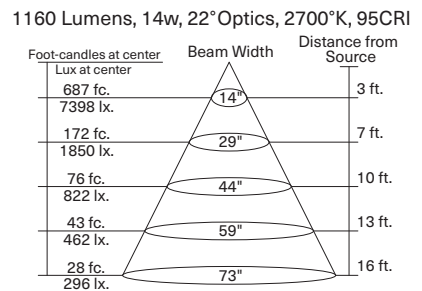

### LED-716-12

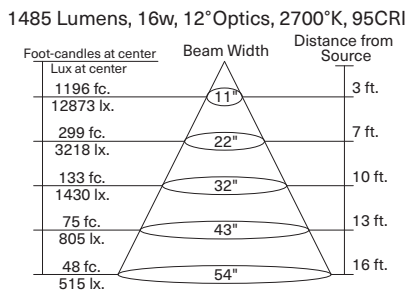

### LED-716-22

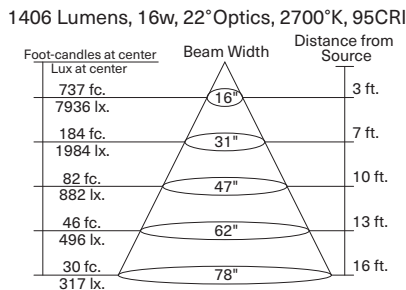

### LED-716-45

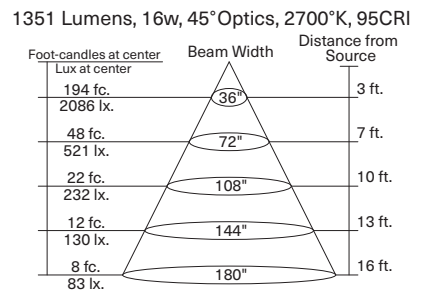

### LED-930-12

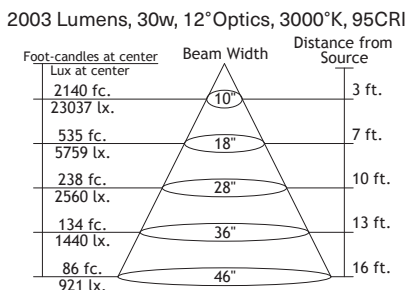

### LED-930-22

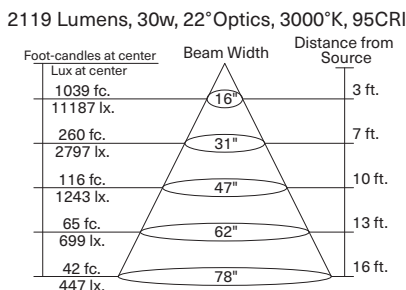

### LED-930-45

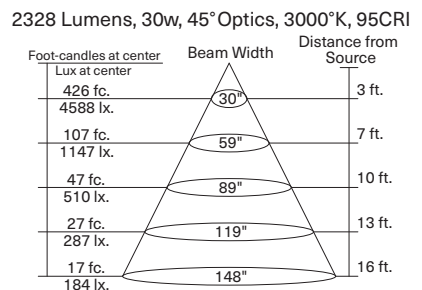

# Modular International, Inc.



## Elements™ 16w LED Module

**16<sub>w</sub>**

**Model :** LED-516

**Wattage:** 16

**Lumens:** 640 at 3000°K

**Equivalent :** 50w MR16

**Kelvin Temperature:** 2850°K or 3000°K (+/- 2%)

**Standard CRI:** 95

**Accessories and customization available:** Tuning, dimming, beam angles, Kelvin temperature, shielding and filtering

**Beam Angles:** 14° Spot, 21° Narrow Flood, 34° Flood, 6° beam angle also available

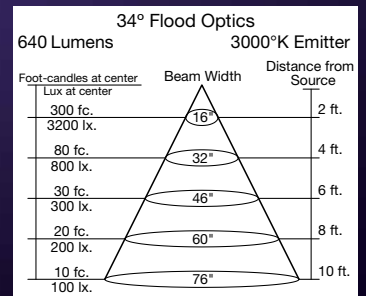
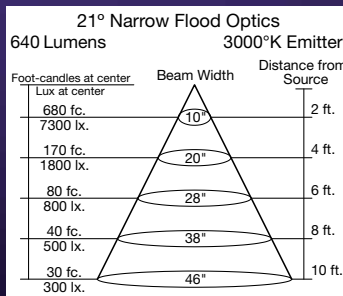
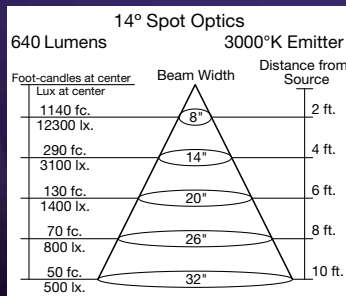

## Elements™ 30w LED Module

**30<sub>w</sub>**

**Model :** LED-530

**Wattage:** 30

**Lumens:** 1200 at 3000°K

**Equivalent :** 20w MR16 Metal Halide

**Kelvin Temperature:** 2850°K or 3000°K (+/- 2%)

**Standard CRI:** 95

**Accessories and customization available:** Tuning, dimming, beam angles, Kelvin temperature, shielding and filtering

**Beam Angles:** 14° Spot, 21° Narrow Flood, 34° Flood, 6° beam angle also available

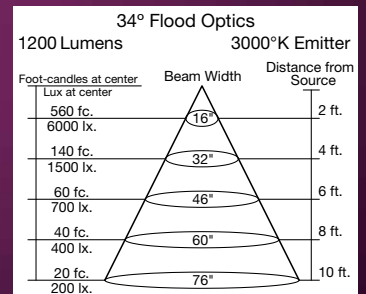
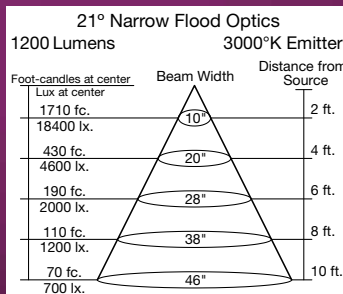
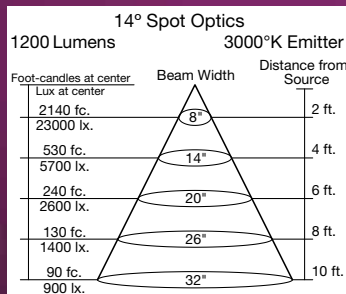

# Modular Multiples®

## Fixture Options

Modular accessories are used individually or in inventive combinations to shield brightness, reduce glare, vary beam patterns, retain direction, and alter color. Dimensions of all fixture options vary with lamp size.

### Ring Sets and Locking Devices (PATENTED)

ADD -LM TO END OF MODEL NUMBER

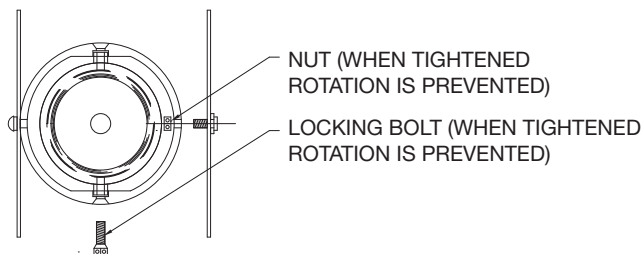

**BOTTOM VIEW**

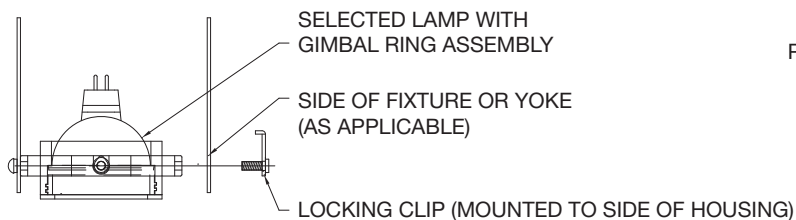

**FRONT VIEW**

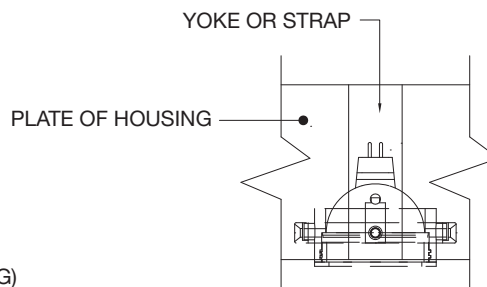

**SIDE VIEW**

### Extendable Yokes

ADD -EY TO END OF MODEL NUMBER

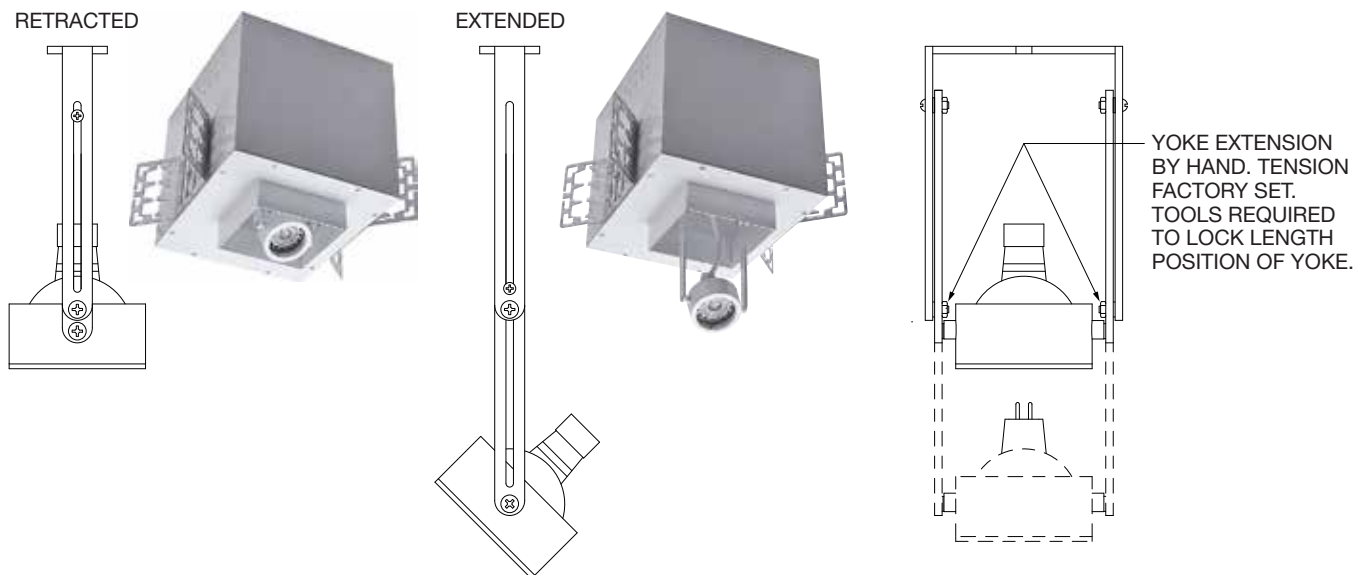

# Modular Multiples®

## Fixture Options

Modular accessories are used individually or in inventive combinations to shield brightness, reduce glare, vary beam patterns, retain direction, and alter color. Fixture option dimensions vary with lamp size.

### Shielding Options

ADD SHIELDING OPTION CODE (BELOW) TO END OF MODEL NUMBER

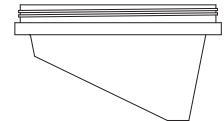

FILTER RING (STANDARD)

SHIELDING CONE (-SC)

SHIELDING CYLINDER (-CY)

WALL WASH CONE (-WWC)

### Filter Media

ADD FILTER MEDIA CODE (BELOW) TO END OF MODEL NUMBER

LED modules accept one 1/8" thick filter. LED direct replacement and legacy lamps accept up to two 1/8" thick filters.

CLEAR GLASS (-CG)

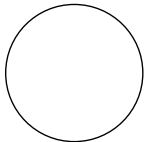

DIFFUSING SPREAD (-DS)

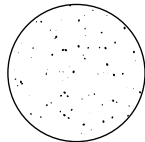

CUBE CELL LOUVER (-CL)

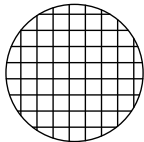

HEXCELL LOUVER (-HL)

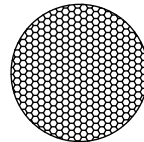

LINEAR SPREAD (-LS)

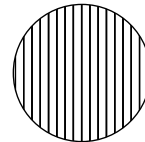

PRISMATIC WIDE SPREAD (-PS)

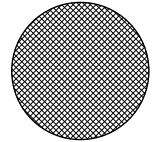

SATIN ETCHED (-SE)

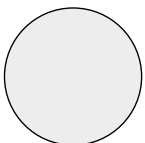

UV BLOCKING (-UB)

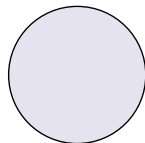

DICHROIC

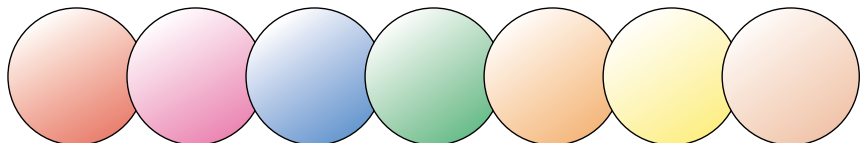

RED (-DR)

MAGENTA (-DM)

BLUE (-DB)

GREEN (-DG)

AMBER (-DA)

YELLOW (-DY)

PEACH (-DP)