

Modular Multiples®

The Original Multiple Light Family of Fixtures

Solid

Surface Mounted - New/Old Work

Outstanding flexibility and design excellence in surface mounted configurations for applications where ceilings are currently installed. Can be wall, ceiling, canopy or pendent mounted with 1/16" (2mm) braided stainless steel cables.

Two Light



MSS-2-LED-512-20-27-2-TI-RD-SM-AWNR-BL

Modular Multiples® Surface Series, two 12 watt LED lamp modules, 2700°K, black housing, drivers/transformers incorporated, round apertures, surface mounted, Lutron Athena Wireless Node-black configuration shown. Other configurations available.

[Download CSI drop-in spec template](#)

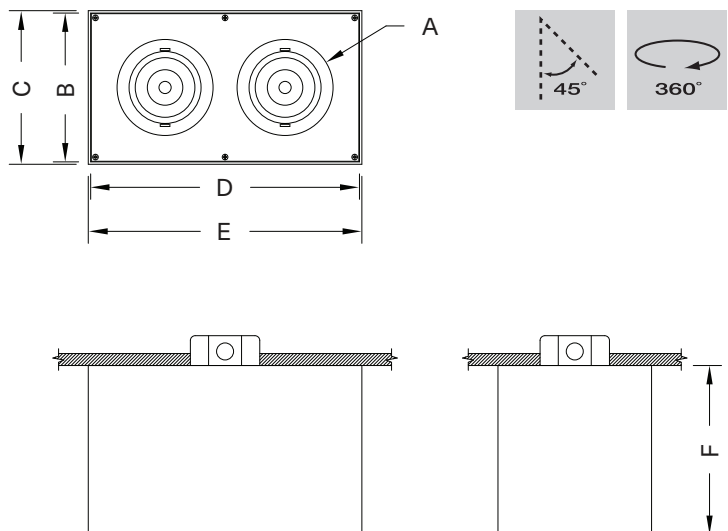

COMPATIBLE CEILING MATERIALS



LIGHTS and DIMENSIONS	A	B	C	D	E	F
LED-507, LED-508, LED-510, LED-511, LED-512	4" 102mm	6-3/4" 171mm	7" 178mm	11-3/4" 298mm	12" 305mm	8-1/4" 210mm
LED-712, LED-714, LED-716, LED-720, LED-920, LED-926, LED-929, LED-932, LED-935	5" 127mm	7-3/4" 197mm	8" 203mm	14" 356mm	14-1/4" 362mm	8-3/4" 222mm

Above measurements shown with 45° of adjustability. Certain driver options may alter housing dimensions. Contact factory for more details.



Modular Multiples®

The Original Multiple Light Family of Fixtures



Solid

Surface Mounted - New/Old Work

- Configurations:**
- 1, 2, 3, 4 light sources standard.
 - Round apertures standard.
 - Custom configurations available.
-
- Housing:**
- Extruded aluminum body.
 - 14 gauge steel face plate.
-
- Finishes:**
- Housing and ring sets powder coated – White or black standard.
 - Custom colors available.
-
- Electrical:**
- One driver/transformer incorporated per light source for multi-circuit wiring.
 - Phase, 0-10V, DALI-2, and DMX dimming options available. Consult factory for driver options.
 - 120/277V available.
 - Listed to UL1598 standards.

[Download CSI drop-in spec template](#)

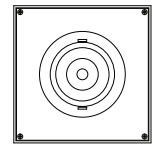

Light Sources: 579e LED Modules

LED-507-20	LED-712-20	LED-920-35
LED-507-30	LED-712-30	LED-920-45
LED-507-40	LED-712-40	LED-920-60
LED-508-20	LED-712-55	LED-920-90
LED-508-30	LED-714-20	LED-926-35
LED-508-40	LED-714-30	LED-926-45
LED-510-20	LED-714-40	LED-926-60
LED-510-30	LED-714-55	LED-926-90
LED-510-40	LED-716-20	LED-929-35
LED-511-20	LED-716-30	LED-929-45
LED-511-30	LED-716-40	LED-929-60
LED-511-40	LED-716-55	LED-929-90
LED-512-20	LED-720-20	LED-932-35
LED-512-30	LED-720-30	LED-932-45
LED-512-40	LED-720-40	LED-932-60
	LED-720-55	LED-932-90
		LED-935-35
		LED-935-45
		LED-935-60
		LED-935-90

LED legacy light source replacements:

MR16LED (-BLD)	PAR30LED (-GLD)
AR111LED (-DLD)	PAR38LED (-JLD)

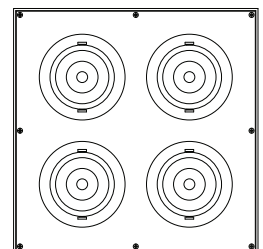
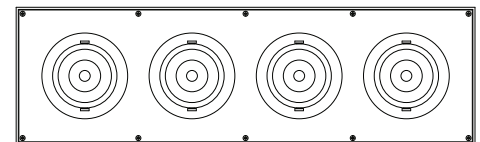
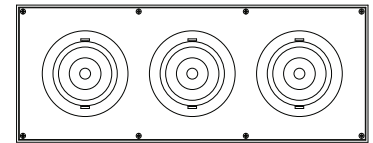
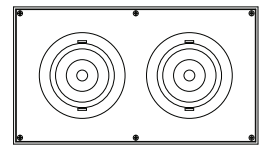

- Mounting:**
- For applications where ceilings are currently installed.
 - Can be wall, ceiling, canopy or pendent mounted with 1/16" (2mm) braided stainless steel cables.
 - Secure to ceiling or wall structure with the appropriate hardware.

- Options:**
- Patented aluminum ring sets and locking devices.
 - Pull down yokes.
 - Filter rings and shielding cylinders.
 - Filter media: up to two 1/8" (3mm) thick filter per light source.
 - Lutron Athena Wireless Node (white or black finish available).

Model # example:

MSS-2-LED-512-20-27-2-TI-RD-SM-AWNR-WH

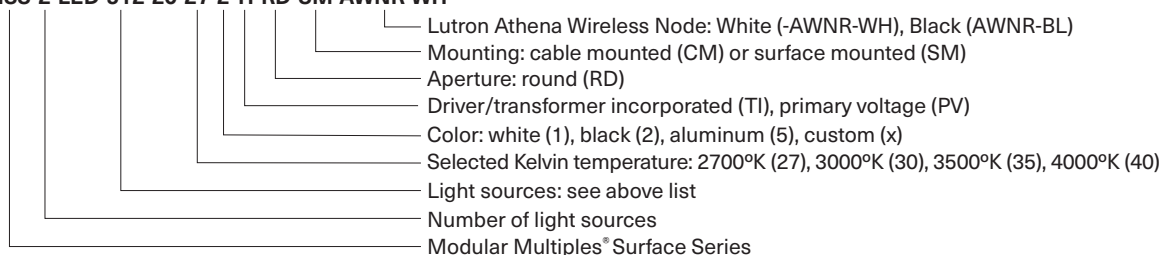

Modular International, Inc.
1-412-734-9000
www.modularinternational.com

Modular Multiples®

The Original Multiple Light Family of Fixtures



579 Available LED Modules

Model Number	Watts	Beam Angle	CRI	Lumens	Lumens per watt
LED-507-20	7	20°	90+	798	114
LED-507-30	7	30°	90+	758	108
LED-507-40	7	40°	90+	761	109
LED-508-20	8	20°	90+	1,060	133
LED-508-30	8	30°	90+	988	124
LED-508-40	8	40°	90+	1,001	125
LED-510-20	10	20°	90+	1,245	125
LED-510-30	10	30°	90+	1,177	118
LED-510-40	10	40°	90+	1,189	119
LED-511-20	11	20°	90+	1,362	124
LED-511-30	11	30°	90+	1,289	117
LED-511-40	11	40°	90+	1,309	119
LED-512-20	12	20°	90+	1,458	122
LED-512-30	12	30°	90+	1,385	115
LED-512-40	12	40°	90+	1,407	117
LED-712-20	12	20°	90+	1,591	133
LED-712-30	12	30°	90+	1,580	132
LED-712-40	12	40°	90+	1,513	126
LED-712-55	12	55°	90+	1,557	130
LED-714-20	14	20°	90+	1,885	135
LED-714-30	14	30°	90+	1,858	133
LED-714-40	14	40°	90+	1,780	127
LED-714-55	14	55°	90+	1,834	131
LED-716-20	16	20°	90+	2,203	138
LED-716-30	16	30°	90+	2,174	136
LED-716-40	16	40°	90+	2,080	130
LED-716-55	16	55°	90+	2,149	134
LED-720-20	20	20°	90+	2,650	133
LED-720-30	20	30°	90+	2,583	129
LED-720-40	20	40°	90+	2,462	123
LED-720-55	20	55°	90+	2,554	128
LED-920-35	20	35°	90+	3,028	151
LED-920-45	20	45°	90+	2,993	150
LED-920-60	20	60°	90+	3,019	151
LED-920-90	20	90°	90+	3,112	156
LED-926-35	26	35°	90+	3,868	149
LED-926-45	26	45°	90+	3,813	147
LED-926-60	26	60°	90+	3,871	149
LED-926-90	26	90°	90+	3,985	153
LED-929-35	29	35°	90+	4,264	147
LED-929-45	29	45°	90+	4,190	144
LED-929-60	29	60°	90+	4,272	147
LED-929-90	29	90°	90+	4,406	152
LED-932-35	32	35°	90+	4,645	145
LED-932-45	32	45°	90+	4,575	143
LED-932-60	32	60°	90+	4,652	145
LED-932-90	32	90°	90+	4,819	151
LED-935-35	35	35°	90+	5,034	144
LED-935-45	35	45°	90+	4,986	142
LED-935-60	35	60°	90+	5,095	146
LED-935-90	35	90°	90+	5,224	149

Modular Multiples®

The Original Multiple Light Family of Fixtures

Fixture Options

Extendable Yokes

ADD -EY TO END OF MODEL NUMBER

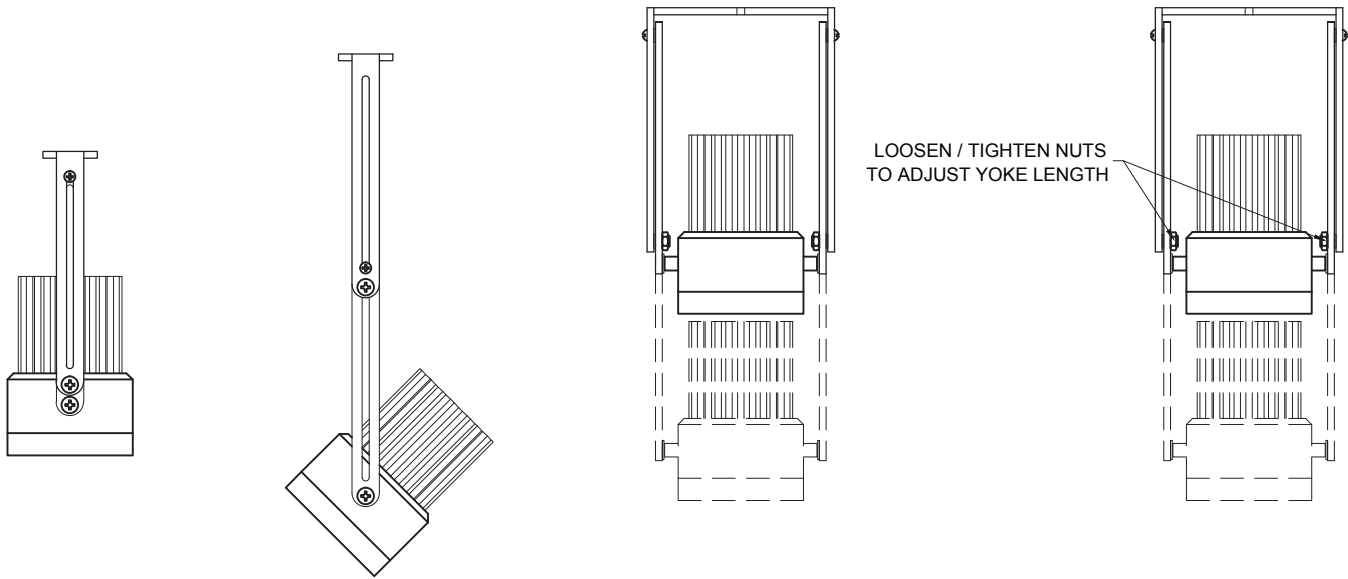

Shielding Options

ADD SHIELDING OPTION CODE (BELOW) TO END OF MODEL NUMBER



FILTER RING (STANDARD)

SHIELDING CYLINDER (-CY)

Lutron Athena Wireless Nodes



ATHENA WIRELESS NODE
WHITE (AWN-WH)

ATHENA WIRELESS NODE
BLACK (AWN-BL)

Filter Media

ADD FILTER MEDIA CODE (BELOW) TO END OF MODEL NUMBER

