

# Modular Multiples®

## Solid

Surface Mounted - New/Old Work

Outstanding flexibility and design excellence in surface mounted configurations for applications where ceilings are currently installed. Can be wall, ceiling, canopy or pendent mounted with 1/16" braided stainless steel cables.

### Custom Four Lamp



MS-4-B-x-TI-RD-SM

Modular Multiples® Surface Solid Series,  
custom configuration, four MR16 lamps,  
stainless steel housing, transformer incorporated,  
round aperture, surface mounted configuration.  
Other configurations available.

[Download CSI drop-in spec template](#)

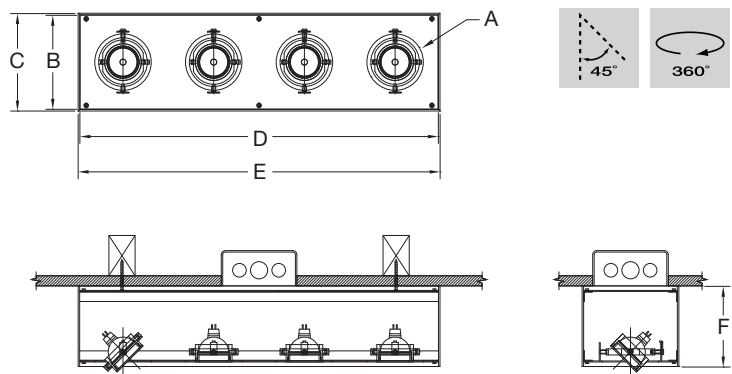

LAMPS and DIMENSIONS	A	B	C	D	E	F	G
LED506, LED513 / MR16LED / MR16	ø3-1/2" ø89mm	5-7/8" 149mm	6-1/16" 154mm	1' 10-1/4" 565mm	1' 10-7/16" 570mm	5" 127mm	6-1/8" 156mm

# Modular Multiples®

The Original Multiple Lamp Family of Fixtures

5

## Solid

Surface Mounted - New/Old Work



- Configurations:**
- 1, 2, 3, 4 light configurations standard
  - Round apertures standard
  - Custom configurations available

- Housing:**
- Extruded aluminum body
  - 14 gauge steel face plate

- Finishes:**
- Powder coated - white, black or aluminum standard
  - Custom colors available
  - Stainless steel / satin nickel available

- Electrical:**
- Internal electronic power supply(s) / transformer(s) / ballast(s)
  - Dimmable (not applicable on HID products)
  - One power supply / transformer per lamp allowing for multi-circuit wiring.
  - 120v and 277v available
  - Listed to UL1598 standards

[Download CSI drop-in spec template](#)

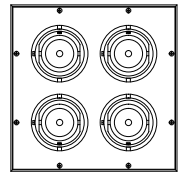
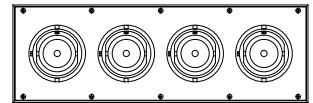
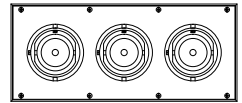
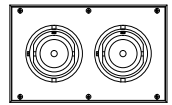
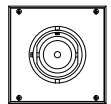

**Lamping:**

**Standard LED Modules**

6w LED-506-6	12w LED-512-12	12w LED-512-22
8w LED-708-6	14w LED-714-12	14w LED-714-22
16w LED-716-12	16w LED-716-22	16w LED-716-45
30w LED-930-12	30w LED-930-22	30w LED-930-45

**Direct Replacement LED or Legacy Lamps:**

MR16LED (BLD)	MR16 HALOGEN (B)	MR16CMH (BH)
AR111LED (DLD)	AR111 HALOGEN (D)	CDMR111 (S)
PAR30LED (GLD)	PAR30 (G)	PAR30HID (H)
PAR38LED (JLD)	PAR38 (J)	PAR38HID (K)

**Mounting:**

- For applications where ceilings are currently installed.
- Can be wall, ceiling, canopy or pendant mounted with 1/16" braided stainless steel cables.
- Secure to ceiling or wall structure with the appropriate hardware.

**Options:**

- Patented die-cast aluminum ring sets and locking devices
- Pull down yokes
- Shielding cones
- Filter media
  - LED modules accept one 1/8" thick filter
  - LED direct replacement and legacy lamps accept up to two 1/8" thick filters

**Model # example:**

**MS-2-JLD-2-TI-RD-SM**

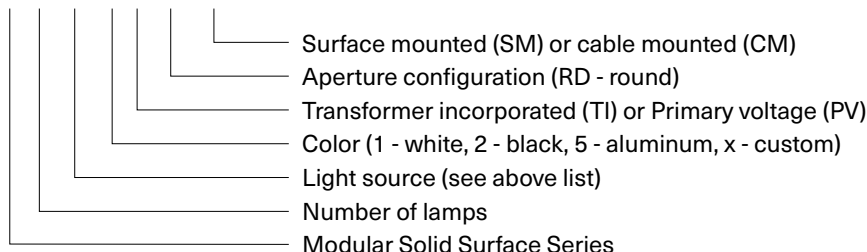

# Modular Multiples®

## Surface Solid

Surface Mounted - Typical Installation

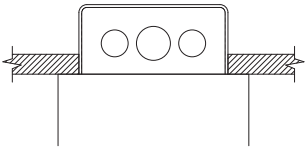

SURFACE MOUNTING

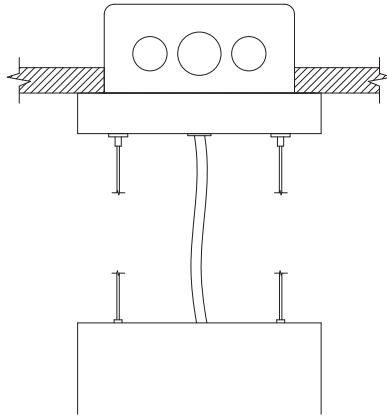

CABLE MOUNTING

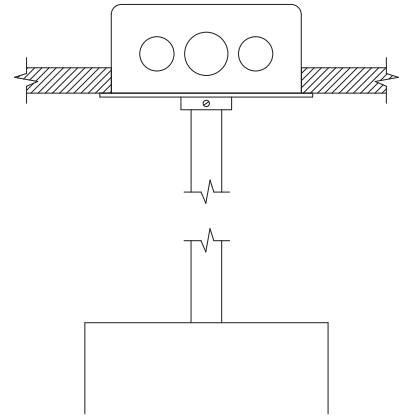

STEM MOUNTING

# Modular Multiples®

The Original Multiple Lamp Family of Fixtures



## Standard LED Modules

### LED-506-6

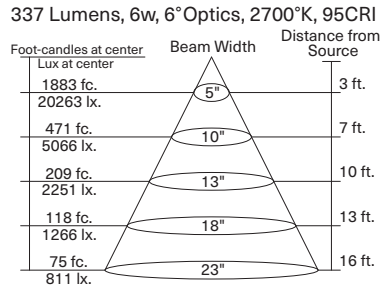

### LED-512-12

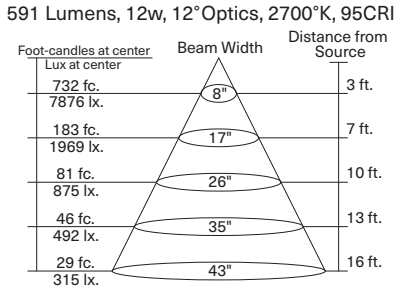

### LED-512-22

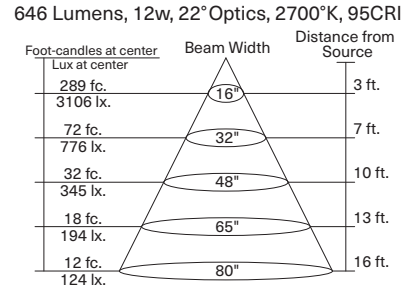

### LED-708-6

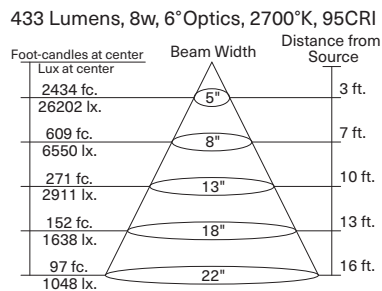

### LED-714-12

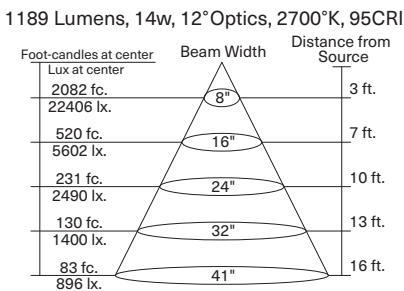

### LED-714-22

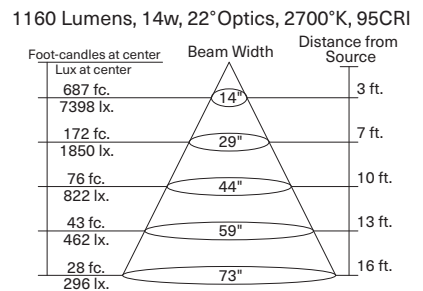

### LED-716-12

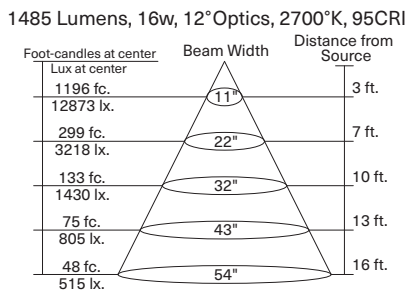

### LED-716-22

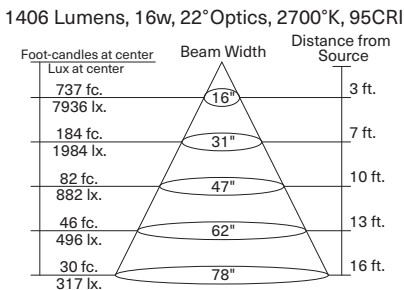

### LED-716-45

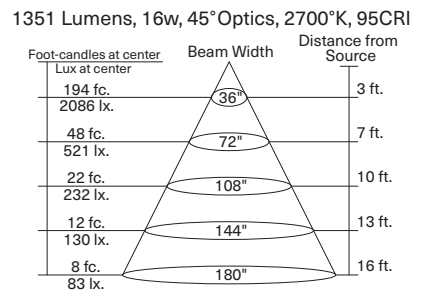

### LED-930-12

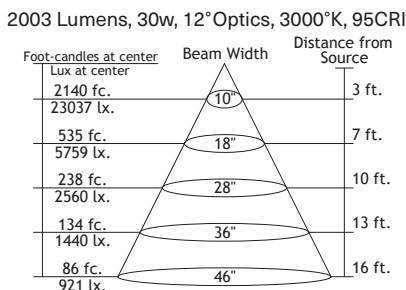

### LED-930-22

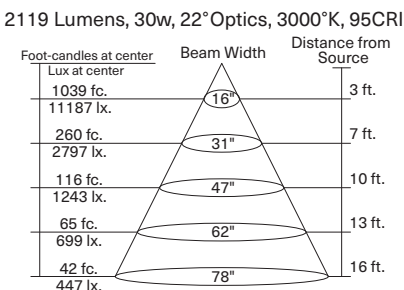

### LED-930-45

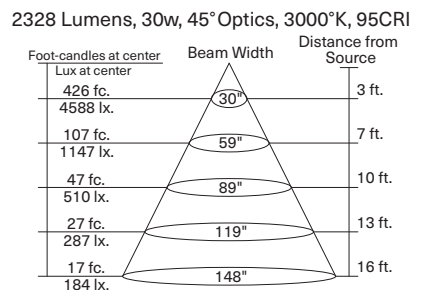

# Modular International, Inc.



## Elements™ 16w LED Module

**16<sub>w</sub>**

**Model :** LED-516

**Wattage:** 16

**Lumens:** 640 at 3000°K

**Kelvin Temperature:** 2850°K or 3000°K (+/- 2%)

**Standard CRI:** 95

**Accessories and customization available:** Tuning, dimming, beam angles, Kelvin temperature, shielding and filtering

**Beam Angles:** 14° Spot, 21° Narrow Flood, 34° Flood, 6° beam angle also available

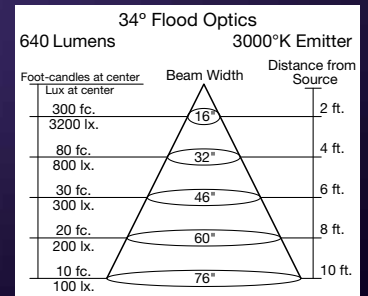
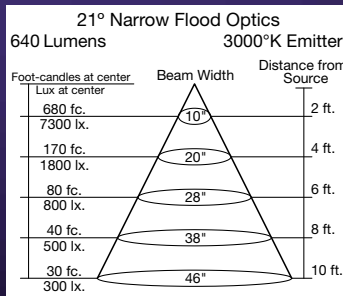
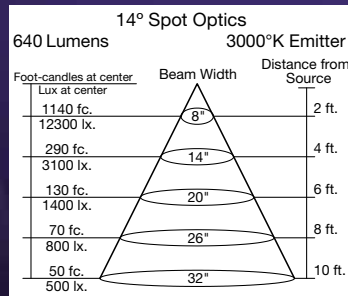

## Elements™ 30w LED Module

**30<sub>w</sub>**

**Model :** LED-530

**Wattage:** 30

**Lumens:** 1200 at 3000°K

**Kelvin Temperature:** 2850°K or 3000°K (+/- 2%)

**Standard CRI:** 95

**Accessories and customization available:** Tuning, dimming, beam angles, Kelvin temperature, shielding and filtering

**Beam Angles:** 14° Spot, 21° Narrow Flood, 34° Flood, 6° beam angle also available

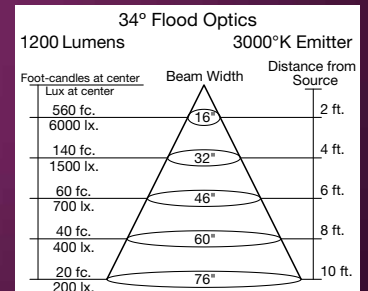
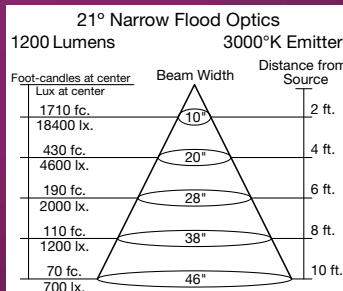
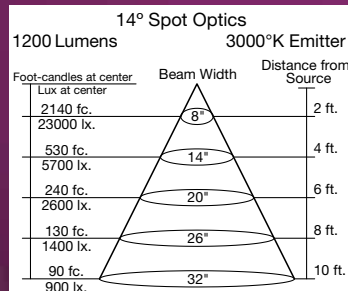

# Modular Multiples®

## Fixture Options

Modular accessories are used individually or in inventive combinations to shield brightness, reduce glare, vary beam patterns, retain direction, and alter color. Dimensions of all fixture options vary with lamp size.

### Ring Sets and Locking Devices (PATENTED)

ADD -LM TO END OF MODEL NUMBER

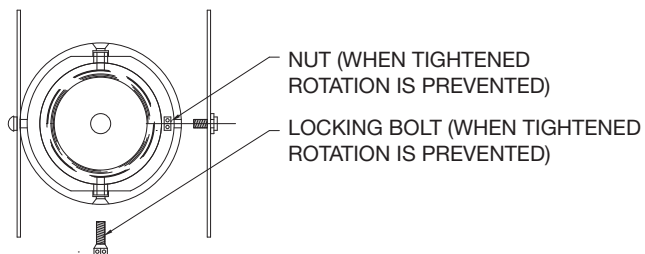

NUT (WHEN TIGHTENED  
ROTATION IS PREVENTED)  
LOCKING BOLT (WHEN TIGHTENED  
ROTATION IS PREVENTED)

**BOTTOM VIEW**

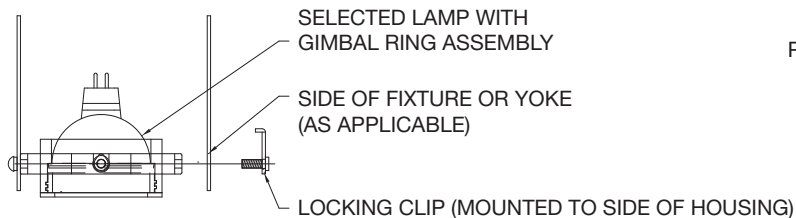

SELECTED LAMP WITH  
GIMBAL RING ASSEMBLY  
SIDE OF FIXTURE OR YOKE  
(AS APPLICABLE)

LOCKING CLIP (MOUNTED TO SIDE OF HOUSING)

**FRONT VIEW**

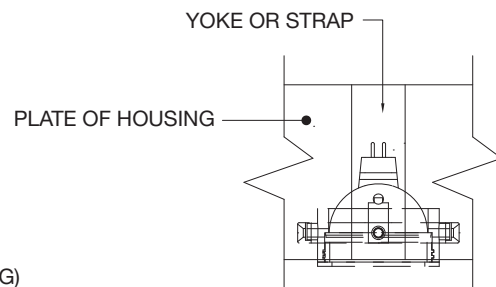

YOKE OR STRAP

PLATE OF HOUSING

**SIDE VIEW**

### Extendable Yokes

ADD -EY TO END OF MODEL NUMBER

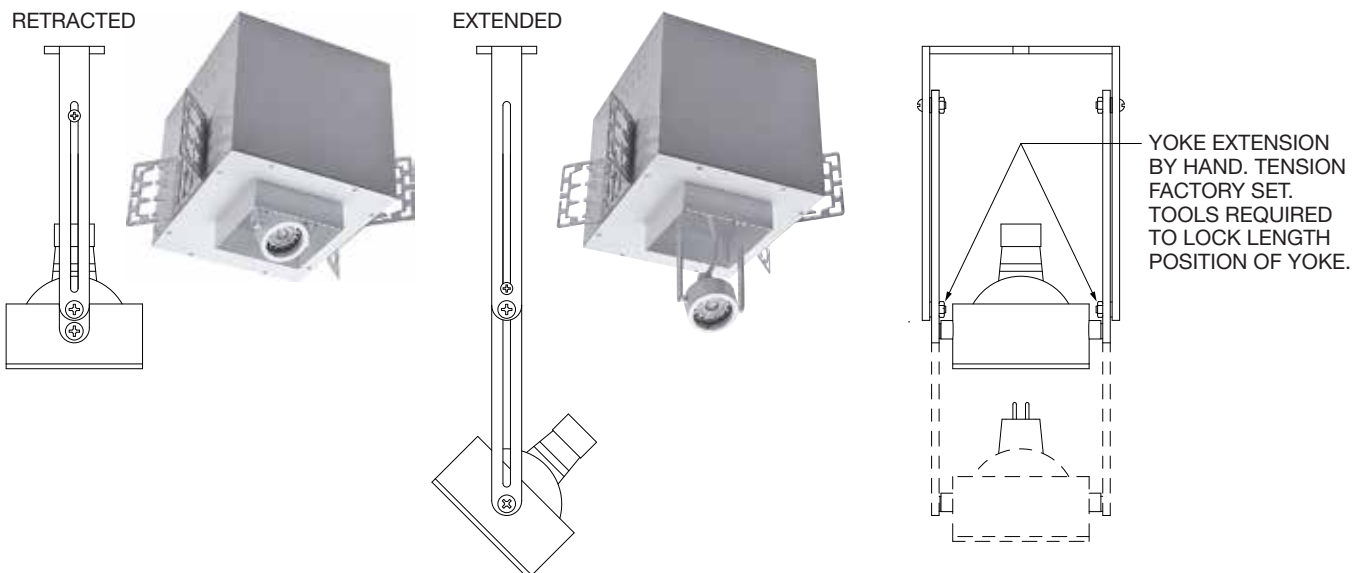

RETRACTED

EXTENDED

YOKE EXTENSION  
BY HAND. TENSION  
FACTORY SET.  
TOOLS REQUIRED  
TO LOCK LENGTH  
POSITION OF YOKE.

# Modular Multiples®

## Fixture Options

Modular accessories are used individually or in inventive combinations to shield brightness, reduce glare, vary beam patterns, retain direction, and alter color. Fixture option dimensions vary with lamp size.

### Shielding Options

ADD SHIELDING OPTION CODE (BELOW) TO END OF MODEL NUMBER

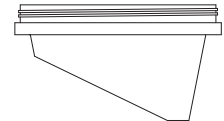
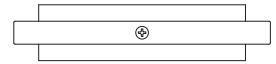
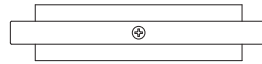
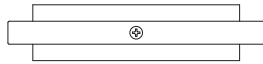
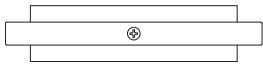

FILTER RING (STANDARD)

SHIELDING CONE (-SC)

SHIELDING CYLINDER (-CY)

WALL WASH CONE (-WWC)

### Filter Media

ADD FILTER MEDIA CODE (BELOW) TO END OF MODEL NUMBER

LED modules accept one 1/8" thick filter. LED direct replacement and legacy lamps accept up to two 1/8" thick filters.

CLEAR GLASS (-CG)

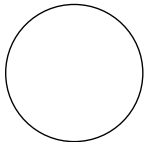

DIFFUSING SPREAD (-DS)

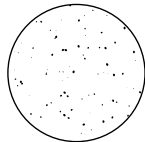

CUBE CELL LOUVER (-CL)

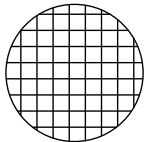

HEXCELL LOUVER (-HL)

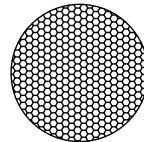

LINEAR SPREAD (-LS)

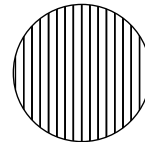

PRISMATIC WIDE SPREAD (-PS)

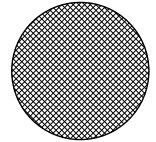

SATIN ETCHED (-SE)

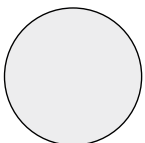

UV BLOCKING (-UB)

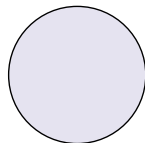

DICHROIC

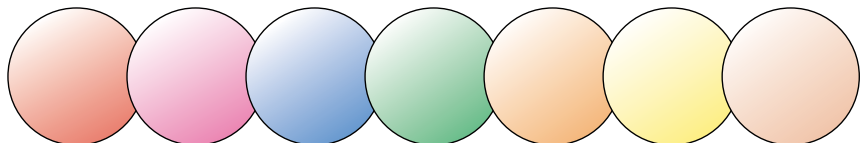

RED (-DR)

MAGENTA (-DM)

BLUE (-DB)

GREEN (-DG)

AMBER (-DA)

YELLOW (-DY)

PEACH (-DP)