

Modular Multiples®

Trimmed

Recessed - New/Old Work

Built to your specifications, these high-quality fixtures feature a trimmed aperture for a clean, refined appearance. Available with transformer incorporated, transformer attached, and remote transformer configurations for new and old work installations. The series is adaptable to plaster, gypboard, wood, or acoustical ceilings. This series conforms to USA standards. A companion series that conforms to Asian and European standards is also available.

Four Lamp Square



M-4-BLD-2-TA-SQ-TR

Modular Multiples® Trimmed Series, four MR16LED lamps, black housing, transformer attached, square aperture, trimmed configuration shown.

Other configurations available.

[Download CSI drop-in spec template](#)

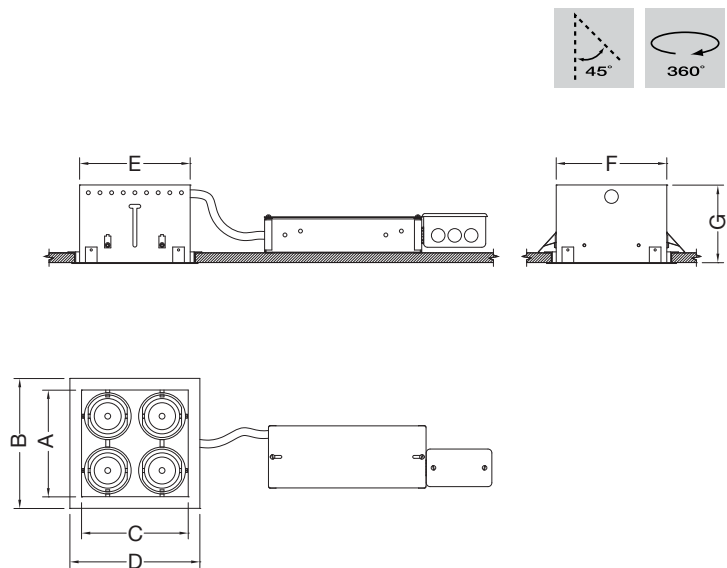

LAMPS and DIMENSIONS	A	B	C	D	E	F	G
LED506, LED513 / MR16LED / MR16	6-7/8" 175mm	8-3/8" 213mm	8-3/8" 213mm	1'3-3/8" 391mm	7-1/8" 181mm	7-1/8" 181mm	5" 127mm
LED708, 714, 716, 930 / AR111LED / AR111	1'2" 356mm	1'2" 356mm	1'4" 406mm	2'3-3/4" 705mm	1'2-1/4" 362mm	1'2-1/4" 362mm	6" 152mm

Modular Multiples®

The Original Multiple Lamp Family of Fixtures

4

Trimmed

Recessed - New/Old Work



- Configurations:**
- 1, 2, 3, 4 light units standard
 - Custom configurations available

- Housing:**
- Fabricated 18 gauge steel supplied with adjustable mounting brackets
 - 14 gauge steel trim flange
 - Available for airtight or IC rated applications

- Finishes:**
- Powder coated - white or black standard
 - Custom colors available
 - Stainless steel / satin nickel available

- Electrical:**
- Internal electronic power supply(s) /transformer(s) / ballast(s)
 - Dimmable (not applicable on HID products)
 - One power supply / transformer per lamp allowing for multi-circuit wiring.
 - 120v and 277v available
 - Listed to UL1598 standards

Lamping:

Standard LED Modules

6w LED-506-6	12w LED-512-12	12w LED-512-22
8w LED-708-6	14w LED-714-12	14w LED-714-22
16w LED-716-12	16w LED-716-22	16w LED-716-45
30w LED-930-12	30w LED-930-22	30w LED-930-45

Direct Replacement LED or Legacy Lamps:

MR16LED (BLD)	MR16 HALOGEN (B)	MR16CMH (BH)
AR111LED (DLD)	AR111 HALOGEN (D)	CDMR111 (S)
PAR30LED (GLD)	PAR30 (G)	PAR30HID (H)
PAR38LED (JLD)	PAR38 (J)	PAR38HID (K)

Mounting:

- For applications where ceilings are currently installed.
- An opening is cut into the ceiling material to fit the Mounting Frame.
- Housing connected to 18 gauge galvanized steel transformer / wiring section via 24" flexible metal conduit
- Fixture wiring connections are made and fixture is inserted through the installed frame and secured with provided hardware

Options:

- Patented die-cast aluminum ring sets and locking devices
- Pull down yokes
- Shielding cones
- Filter media
 - LED modules accept one 1/8" thick filter
 - LED direct replacement and legacy lamps accept up to two 1/8" thick filters

Model # example:

M-3-BLD-2-TA-REC-TR

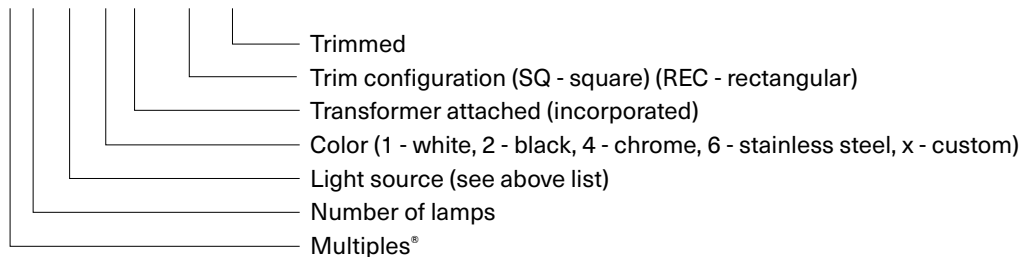

[Download CSI drop-in spec template](#)

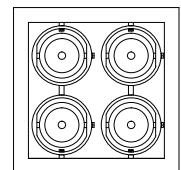
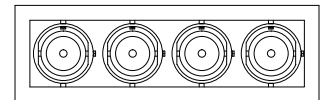
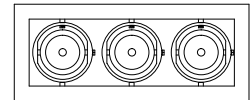
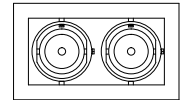
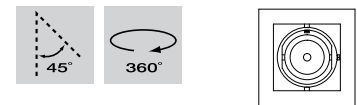

Modular Multiples®

Trimmed TA Typical Installation

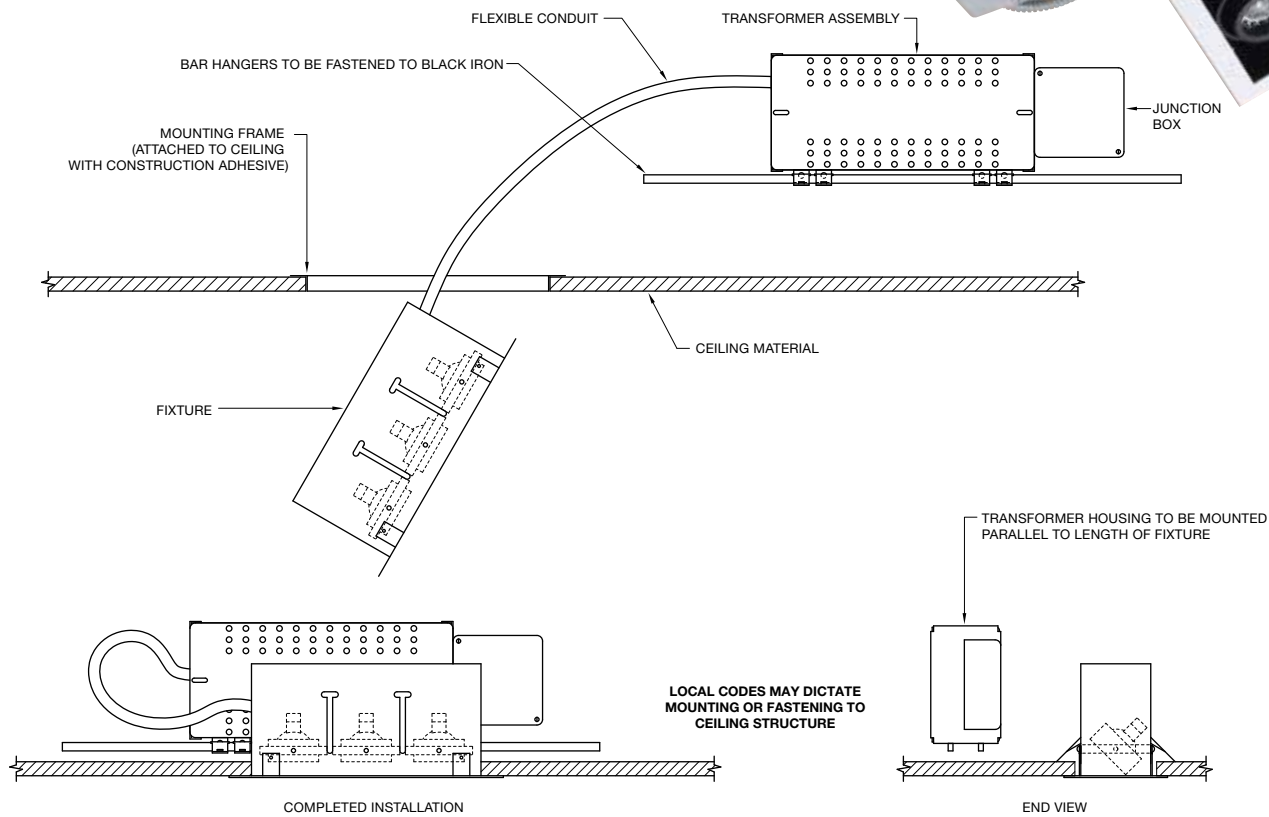
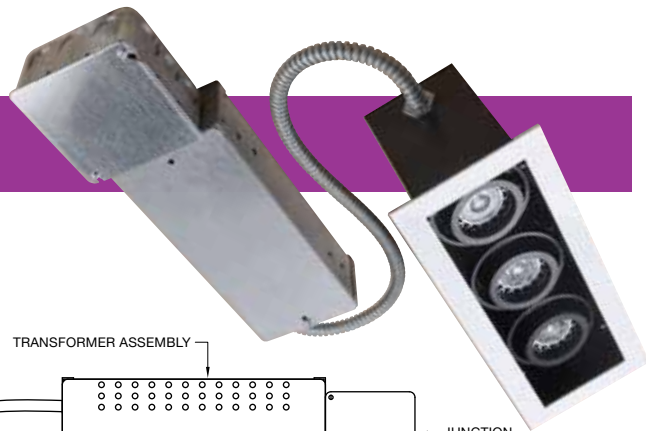

1 + 2 Light Transformer Housing

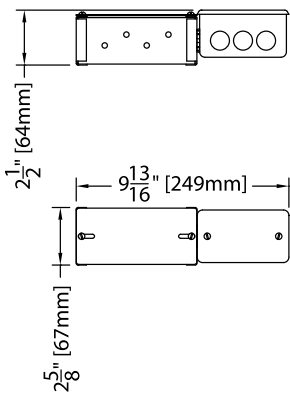

3 + 4 Light Transformer Housing

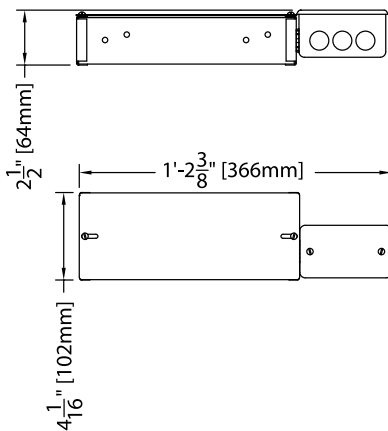

5 + 6 Light Transformer Housing

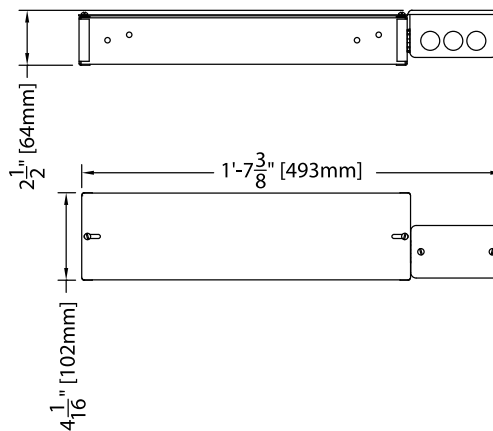

Modular Multiples®

The Original Multiple Lamp Family of Fixtures



Standard LED Modules

LED-506-6

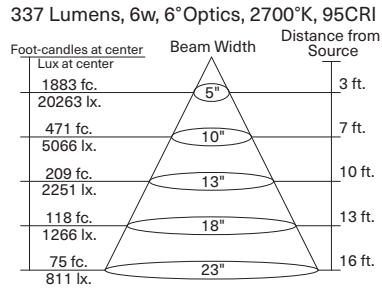

LED-512-12

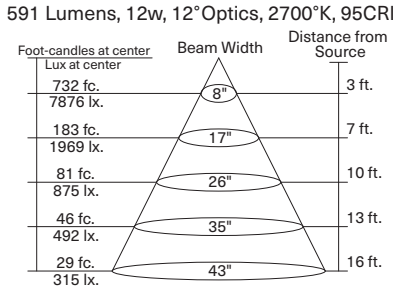

LED-512-22

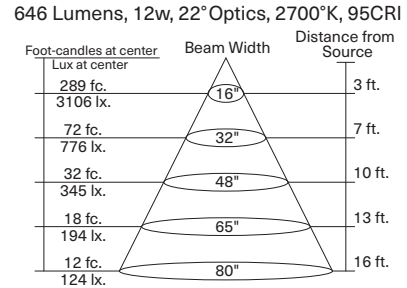

LED-708-6

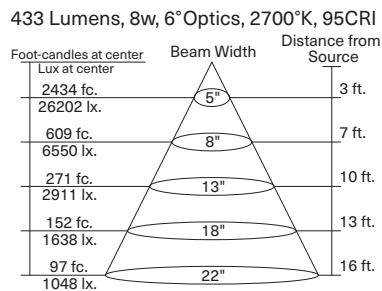

LED-714-12

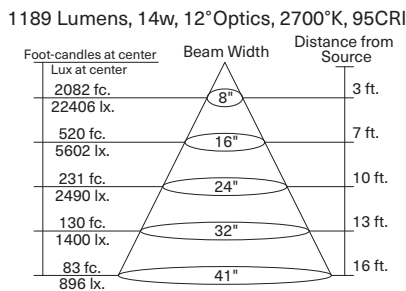

LED-714-22

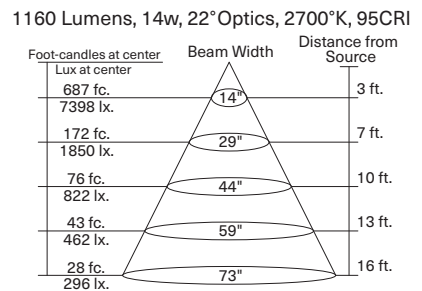

LED-716-12

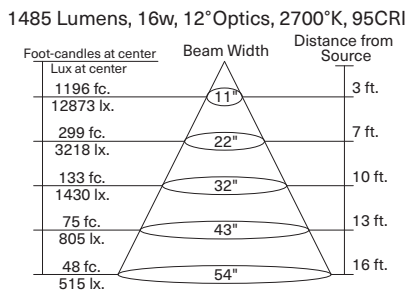

LED-716-22

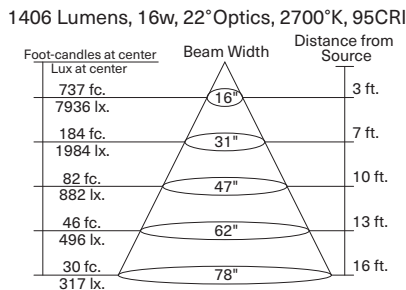

LED-716-45

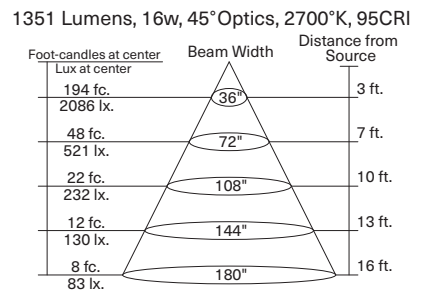

LED-930-12

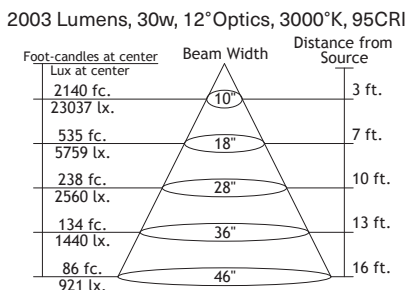

LED-930-22

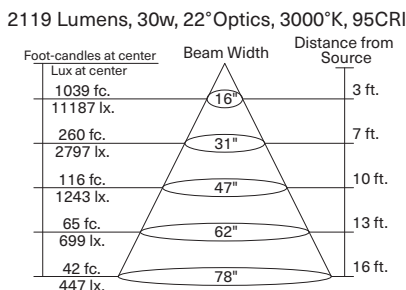

LED-930-45

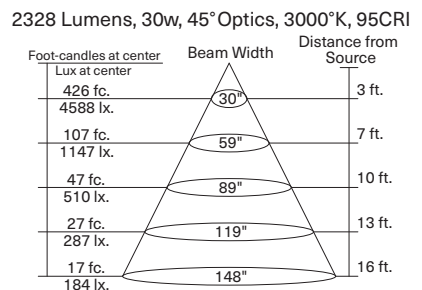

Modular International, Inc.



Elements™ 16w LED Module

16_w

Model : LED-516

Wattage: 16

Lumens: 640 at 3000°K

Kelvin Temperature: 2850°K or 3000°K (+/- 2%)

Standard CRI: 95

Accessories and customization available: Tuning, dimming, beam angles, Kelvin temperature, shielding and filtering

Beam Angles: 14° Spot, 21° Narrow Flood, 34° Flood, 6° beam angle also available

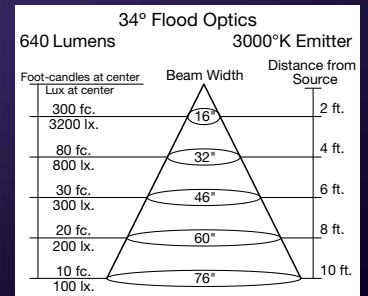
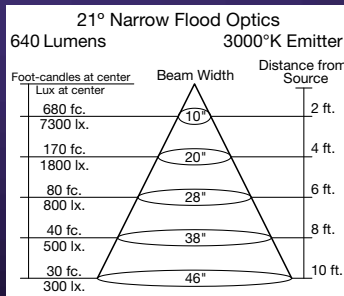
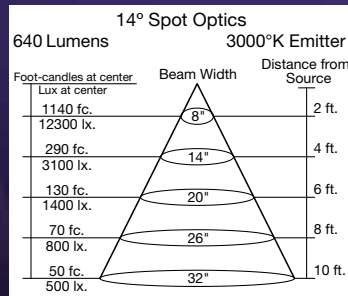

Elements™ 30w LED Module

30_w

Model : LED-530

Wattage: 30

Lumens: 1200 at 3000°K

Kelvin Temperature: 2850°K or 3000°K (+/- 2%)

Standard CRI: 95

Accessories and customization available: Tuning, dimming, beam angles, Kelvin temperature, shielding and filtering

Beam Angles: 14° Spot, 21° Narrow Flood, 34° Flood, 6° beam angle also available

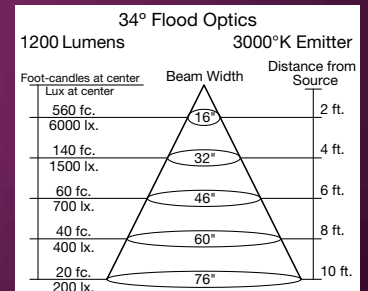
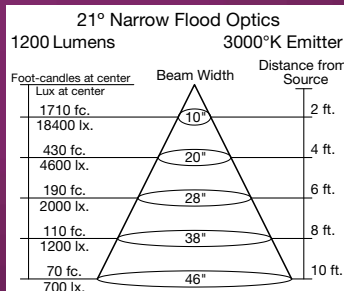
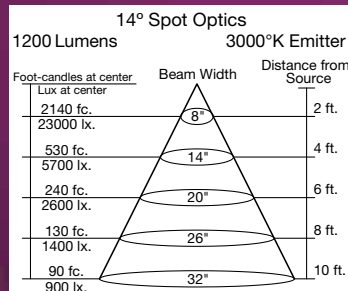

Modular Multiples®

Fixture Options

Modular accessories are used individually or in inventive combinations to shield brightness, reduce glare, vary beam patterns, retain direction, and alter color. Dimensions of all fixture options vary with lamp size.

Ring Sets and Locking Devices (PATENTED)

ADD -LM TO END OF MODEL NUMBER

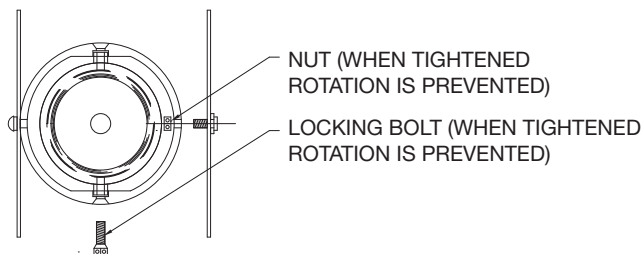

NUT (WHEN TIGHTENED
ROTATION IS PREVENTED)
LOCKING BOLT (WHEN TIGHTENED
ROTATION IS PREVENTED)

BOTTOM VIEW

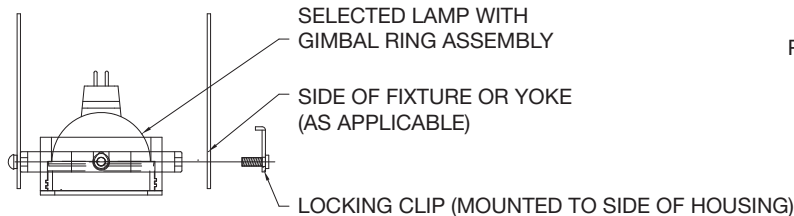

SELECTED LAMP WITH
GIMBAL RING ASSEMBLY
SIDE OF FIXTURE OR YOKE
(AS APPLICABLE)

LOCKING CLIP (MOUNTED TO SIDE OF HOUSING)

FRONT VIEW

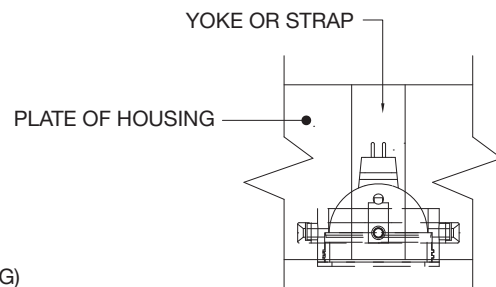

YOKE OR STRAP

PLATE OF HOUSING

SIDE VIEW

Extendable Yokes

ADD -EY TO END OF MODEL NUMBER

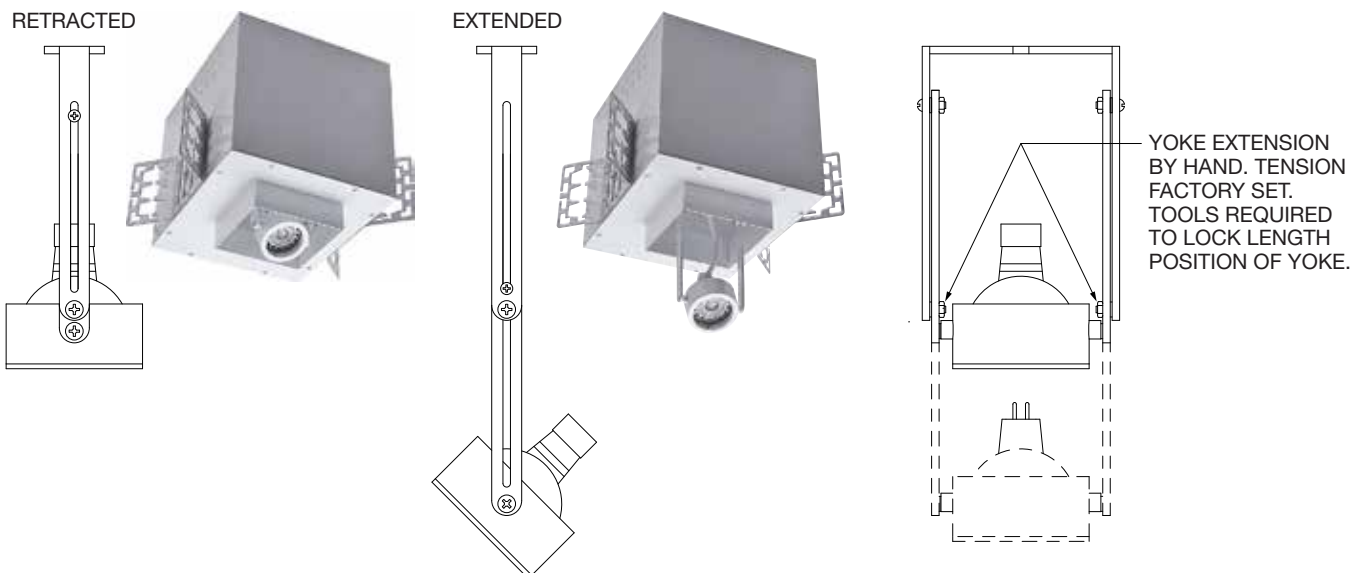

YOKE EXTENSION
BY HAND. TENSION
FACTORY SET.
TOOLS REQUIRED
TO LOCK LENGTH
POSITION OF YOKE.

Modular Multiples®

Fixture Options

Modular accessories are used individually or in inventive combinations to shield brightness, reduce glare, vary beam patterns, retain direction, and alter color. Fixture option dimensions vary with lamp size.

Shielding Options

ADD SHIELDING OPTION CODE (BELOW) TO END OF MODEL NUMBER

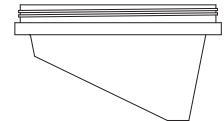

FILTER RING (STANDARD)

SHIELDING CONE (-SC)

SHIELDING CYLINDER (-CY)

WALL WASH CONE (-WWC)

Filter Media

ADD FILTER MEDIA CODE (BELOW) TO END OF MODEL NUMBER

LED modules accept one 1/8" thick filter. LED direct replacement and legacy lamps accept up to two 1/8" thick filters.

CLEAR GLASS (-CG)

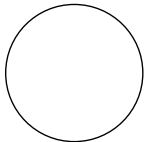

DIFFUSING SPREAD (-DS)

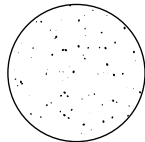

CUBE CELL LOUVER (-CL)

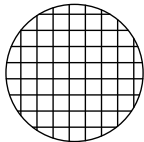

HEXCELL LOUVER (-HL)

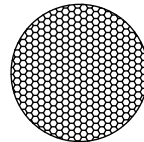

LINEAR SPREAD (-LS)

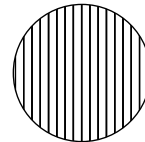

PRISMATIC WIDE SPREAD (-PS)

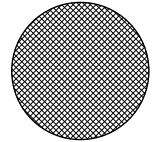

SATIN ETCHED (-SE)

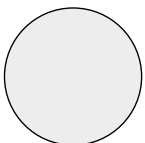

UV BLOCKING (-UB)

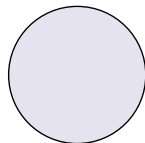

DICHROIC

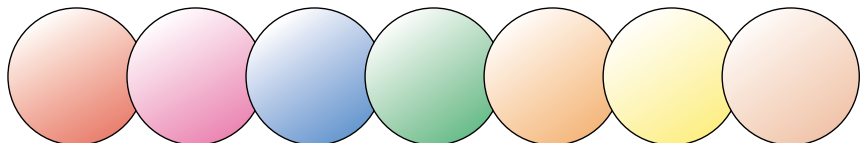

RED (-DR)

MAGENTA (-DM)

BLUE (-DB)

GREEN (-DG)

AMBER (-DA)

YELLOW (-DY)

PEACH (-DP)