

Modular Multiples®

The Original Multiple Light Family of Fixtures

Apertures®

Recessed - Trimless - New/Old Work

These elegant, trimless fixtures are thoroughly flexible in application. Apertures® preformed panels are easily grouped in linear or nonlinear patterns of any length or diameter, giving architects and designers the ability to create artful, imaginative, and seamless ceiling patterns. Round, square, and rectangular apertures with patented accessories such as locking rings and shielding filter media systems are standard. Custom configurations available. Fixture dimensions vary with light type.

Three Light Square Apertures

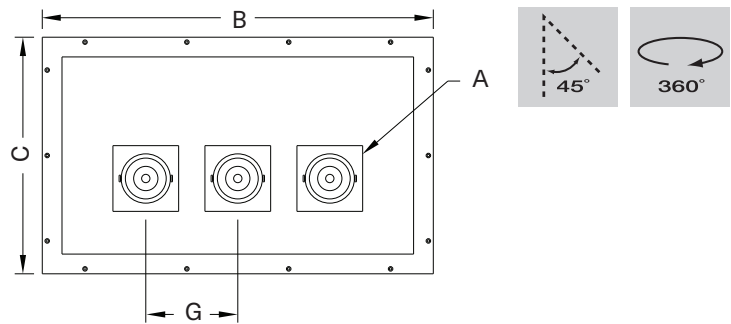
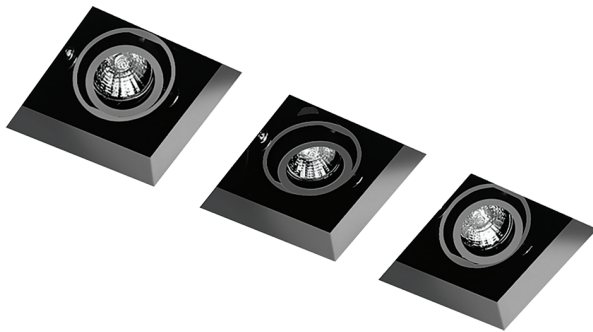

MAS-3-LEDDW-507-17-1830-1-TI-SQ-AWNR-WH

Modular Multiples® Apertures® Series, three 7 watt LED modules, 1800°K - 3000°K, black housing, drivers/transformers incorporated, square apertures, Lutron Athena Wireless Node-white configuration. Other configurations available.

[Download CSI drop-in spec template](#)

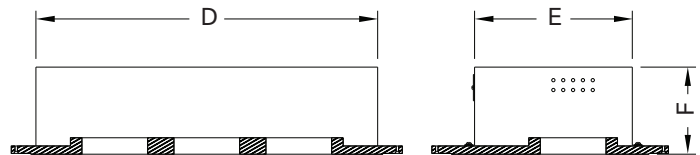

COMPATIBLE CEILING MATERIALS



LIGHTS and DIMENSIONS	A	B	C	D	E	F	G
LEDDW-507, LEDDW-508, LEDDW-509, LEDDW-511	4" x 4" 102 x 102mm	25-3/4" 654mm	16-1/2" 419mm	22" 559mm	10-1/2" 267mm	5-5/8" 143mm	5-1/2" 140mm
LEDDW-713, LEDDW-719, LEDDW-726, LEDDW-730, LEDDW-936, LEDDW-940	5" x 5" 127 x 127mm	29-3/4" 756mm	18" 457mm	26" 660mm	12" 305mm	6-5/8" 168mm	7" 178mm

Above measurements shown with 45° of adjustability. Certain driver options may alter housing dimensions. Contact factory for more details.

Modular Multiples®

The Original Multiple Light Family of Fixtures

Apertures®

Recessed - Trimless - New/Old Work

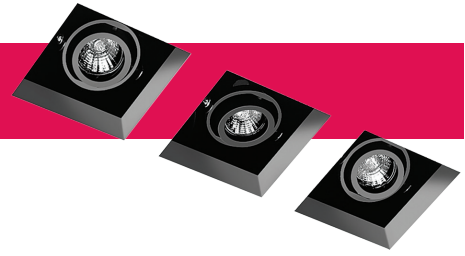

- Configurations:**
- 1, 2, 3, 4 light sources standard.
 - Rectangular, round, and square apertures standard.
 - Standard throat depth of 1-1/4" (32mm).
 - Customization available.
-
- Housing:**
- Fabricated 18 gauge steel housing connected to preformed panel with tape edge on all sides that mates to 5/8" (16mm) drywall or plaster.
 - Available for airtight or IC rated applications.
-
- Finishes:**
- Housing and ring sets powder coated – white or black standard.
 - Custom colors available.
 - Stainless steel / satin nickel available.
 - Panel provided with a white primer finish.
-
- Electrical:**
- One driver/transformer incorporated per light source for multi-circuit wiring.
 - Phase, 0-10V, DALI-2, and DMX dimming options available. Consult factory for available driver options.
 - 120/277V available.
 - Listed to UL1598 standards.

[Download CSI drop-in spec template](#)

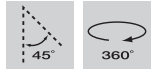

Light Sources: Dim-to-Warm LED Modules

LEDDW-507-17	LEDDW-713-20	LEDDW-936-30
LEDDW-507-30	LEDDW-713-30	LEDDW-936-45
LEDDW-507-40	LEDDW-713-40	LEDDW-936-55
LEDDW-508-17	LEDDW-713-55	LEDDW-936-90
LEDDW-508-30	LEDDW-719-20	LEDDW-940-30
LEDDW-508-40	LEDDW-719-30	LEDDW-940-45
LEDDW-509-17	LEDDW-719-40	LEDDW-940-55
LEDDW-509-30	LEDDW-719-55	LEDDW-940-90
LEDDW-509-40	LEDDW-726-20	
LEDDW-511-17	LEDDW-726-30	
LEDDW-511-30	LEDDW-726-40	
LEDDW-511-40	LEDDW-726-55	
	LEDDW-730-20	
	LEDDW-730-30	
	LEDDW-730-40	
	LEDDW-730-55	

LED legacy light source replacements:

MR16 LED "dim-to-warm" (BLDDW) | AR111 LED "dim-to-warm" (DLDDW)

- Mounting:**
- Housings supported from above with 3/8" (9mm) all-thread rods.
 - Panels designed to be secured to ceiling framing structure via flat head screws through holes provided in tape edge.
-
- Options:**
- Patented aluminum ring sets and locking devices.
 - Pull down yokes.
 - Filter rings and shielding cylinders.
 - Filter media: up to two 1/8" (3mm) thick filter per light source.
 - Lutron Athena Wireless Node (white or black finish available).

Model # example: MAS-3-LEDDW-507-17-1830-1-TI-SQ-AWNR-WH-AT-IC

- Housing: airtight (AT), insulation contact rated (IC)
- Lutron Athena Wireless Node: White (-AWNR-WH), Black (AWNR-BL)
- Aperture: rectangular (REC), round (RD), square (SQ)
- Driver/transformer incorporated (TI), primary voltage (PV)
- Color: white (1), black (2), chrome (4), stainless steel (6), custom (x)
- Kelvin temperature: 1800°K - 3000°K
- Light sources: see above list
- Number of light sources
- Modular Multiples® Apertures® Series

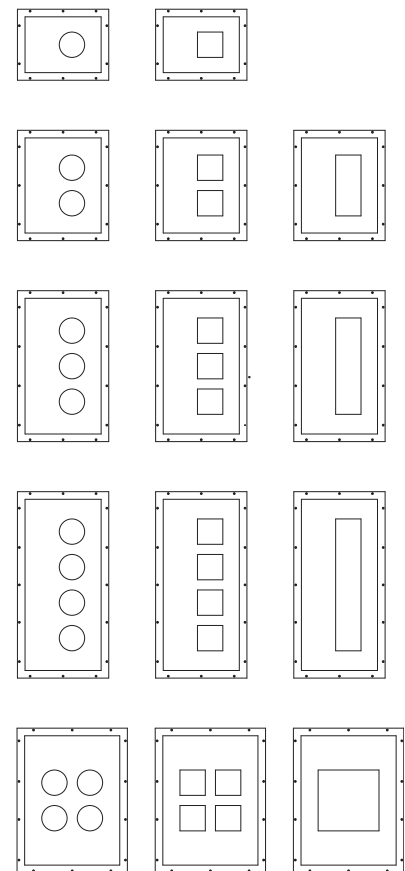

Modular Multiples®

The Original Multiple Light Family of Fixtures



Available LED Modules

Model Number	Watts	Beam Angle	CRI	Lumens	Lumens per watt
LEDDW-507-17	7	17°	90+	419	60
LEDDW-507-30	7	30°	90+	394	56
LEDDW-507-40	7	40°	90+	400	57
LEDDW-508-17	8	17°	90+	575	68
LEDDW-508-30	8	30°	90+	540	70
LEDDW-508-40	8	40°	90+	556	72
LEDDW-509-17	9	17°	90+	705	78
LEDDW-509-30	9	30°	90+	658	73
LEDDW-509-40	9	40°	90+	676	75
LEDDW-511-17	11	17°	90+	830	75
LEDDW-511-30	11	30°	90+	795	72
LEDDW-511-40	11	40°	90+	818	74
LEDDW-713-20	13	20°	90+	1,211	93
LEDDW-713-30	13	30°	90+	1,194	92
LEDDW-713-40	13	40°	90+	1,123	86
LEDDW-713-55	13	55°	90+	1,167	90
LEDDW-719-20	19	20°	90+	1,689	84
LEDDW-719-30	19	30°	90+	1,676	84
LEDDW-719-40	19	40°	90+	1,599	80
LEDDW-719-55	19	55°	90+	1,659	83
LEDDW-726-20	26	20°	90+	2,217	85
LEDDW-726-30	26	30°	90+	2,204	85
LEDDW-726-40	26	40°	90+	2,107	81
LEDDW-726-55	26	55°	90+	2,227	86
LEDDW-730-20	30	20°	90+	2,539	85
LEDDW-730-30	30	30°	90+	2,493	83
LEDDW-730-40	30	40°	90+	2,379	79
LEDDW-730-55	30	55°	90+	2,491	83
LEDDW-936-30	36	30°	90+	3,032	84
LEDDW-936-45	36	45°	90+	3,018	84
LEDDW-936-55	36	55°	90+	3,090	86
LEDDW-936-90	36	90°	90+	3,157	88
LEDDW-940-30	40	30°	90+	3,325	83
LEDDW-940-45	40	45°	90+	3,308	83
LEDDW-940-55	40	55°	90+	3,428	86
LEDDW-940-90	40	90°	90+	3,449	86

Modular Multiples®

The Original Multiple Light Family of Fixtures

Fixture Options

Extendable Yokes

ADD -EY TO END OF MODEL NUMBER

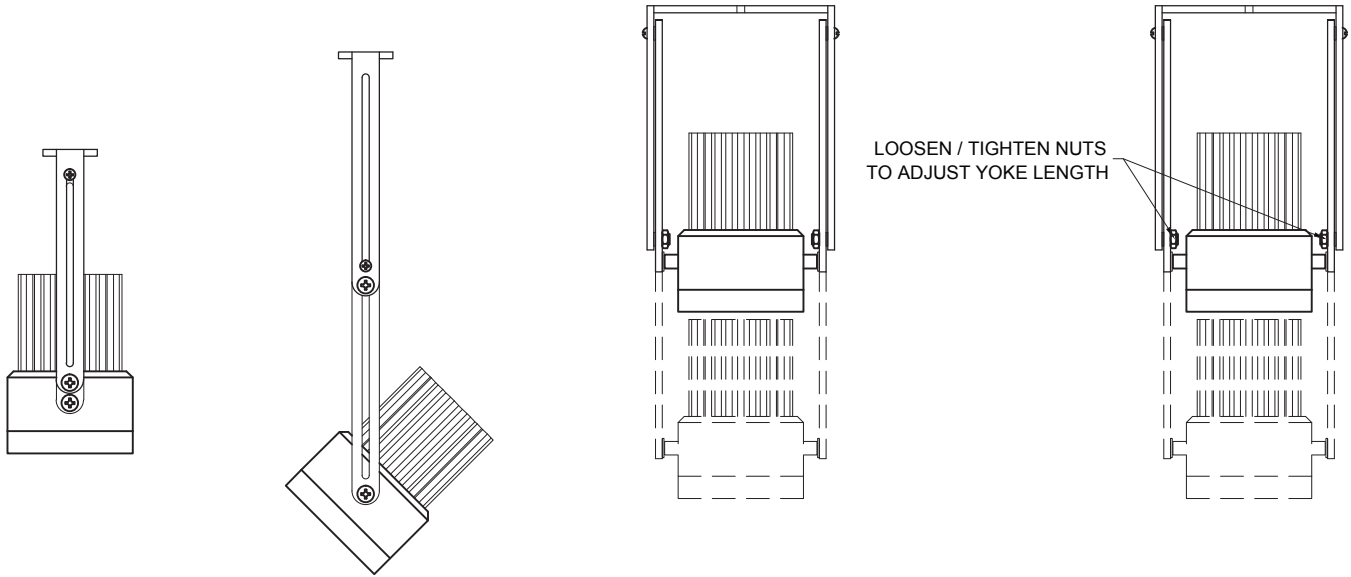

Shielding Options

ADD SHIELDING OPTION CODE (BELOW) TO END OF MODEL NUMBER



FILTER RING (STANDARD)

SHIELDING CYLINDER (-CY)

Lutron Athena Wireless Nodes



ATHENA WIRELESS NODE
WHITE (AWN-WH)

ATHENA WIRELESS NODE
BLACK (AWN-BL)

Filter Media

ADD FILTER MEDIA CODE (BELOW) TO END OF MODEL NUMBER

