

Modular Multiples®

The Original Multiple Light Family of Fixtures

Trimless

Driver/Transformer Incorporated - Recessed - New Work

For new construction applications. Recessed housing is installed via adjustable universal mounting brackets and bar hangers prior to the installation of drywall. Once drywall is installed, the trimless mounting frame is secured to the housing. Spackling compound is applied over the perforated flange and finished for a smooth appearance.

Four Lights Square



MTLS-4-LEDDW-507-17-1830-1-TI-SQ-AWNR-WH

Modular Multiples® Trimless Series, four 7 watt LED modules, 1800°K - 3000°K, white housing, drivers/transformers incorporated, square aperture, Lutron Athena Wireless Node-white configuration shown.

Other configurations available.

[Download CSI drop-in spec template](#)

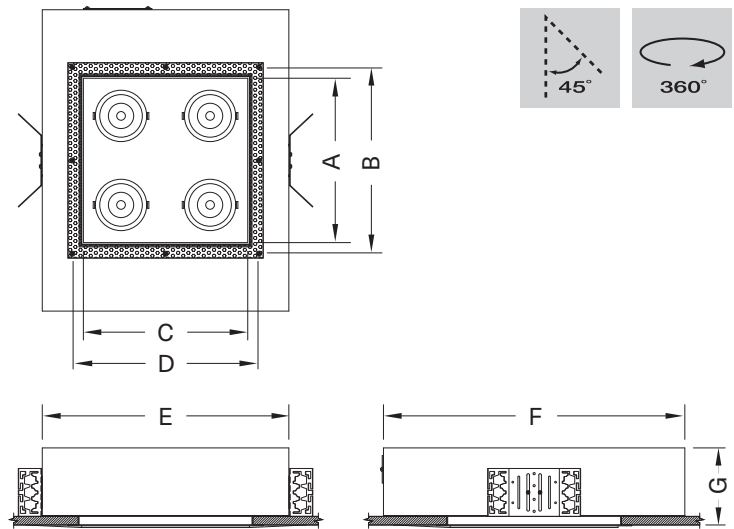

COMPATIBLE CEILING MATERIALS



LIGHTS and DIMENSIONS	A	B	C	D	E	F	G
LEDDW-507, LEDDW-508, LEDDW-509, LEDDW-511	9" 229mm	9-1/4" 235mm	9" 229mm	9-1/4" 235mm	15" 381mm	18" 457mm	5-5/8" 143mm
LEDDW-713, LEDDW-719, LEDDW-726, LEDDW-730, LEDDW-936, LEDDW-940	12" 305mm	12-1/4" 311mm	12" 305mm	12-1/4" 311mm	18" 457mm	22" 559mm	5-5/8" 143mm

Above measurements shown with 45° of adjustability. Certain driver options may alter housing dimensions. Contact factory for more details.



Modular Multiples®

The Original Multiple Light Family of Fixtures

Trimless

Driver/Transformer Incorporated - Recessed - New Work



- Configurations:**
- 1, 2, 3, 4 light sources standard.
 - Custom configurations available.

- Housing:**
- Fabricated 18 gauge steel housing with perforated spackle flange.
 - Available for airtight or IC rated applications.

- Finishes:**
- Housing and ring sets powder coated – white or black standard.
 - Custom colors available.
 - Stainless steel / satin nickel available.

- Electrical:**
- One driver/transformer incorporated per light source for multi-circuit wiring.
 - Phase, 0-10V, DALI-2, and DMX dimming options available. Consult factory for available driver options.
 - 120/277V available.
 - Listed to UL1598 standards.

[Download CSI drop-in spec template](#)

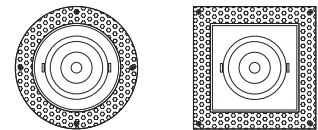
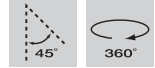

Light Sources: Dim-to-Warm LED Modules

LEDDW-507-17	LEDDW-713-20	LEDDW-936-30
LEDDW-507-30	LEDDW-713-30	LEDDW-936-45
LEDDW-507-40	LEDDW-713-40	LEDDW-936-55
LEDDW-508-17	LEDDW-713-55	LEDDW-936-90
LEDDW-508-30	LEDDW-719-20	LEDDW-940-30
LEDDW-508-40	LEDDW-719-30	LEDDW-940-45
LEDDW-509-17	LEDDW-719-40	LEDDW-940-55
LEDDW-509-30	LEDDW-719-55	LEDDW-940-90
LEDDW-509-40	LEDDW-726-20	
LEDDW-511-17	LEDDW-726-30	
LEDDW-511-30	LEDDW-726-40	
LEDDW-511-40	LEDDW-726-55	
	LEDDW-730-20	
	LEDDW-730-30	
	LEDDW-730-40	
	LEDDW-730-55	

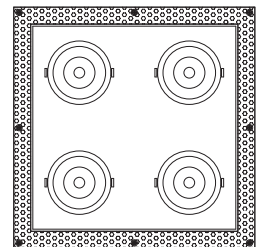
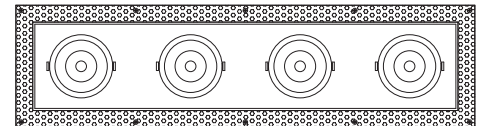
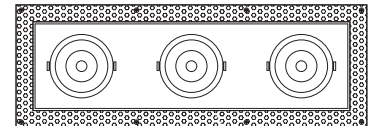
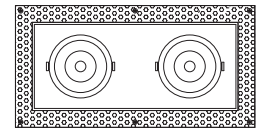

LED legacy light source replacements:

MR16 LED "dim-to-warm" (BLDDW) | AR111 LED "dim-to-warm" (DLDDW)

- Mounting:**
- For new construction applications.
 - Recessed housing installed via adjustable universal mounting brackets and bar hangers prior to the installation of drywall.
 - After drywall installation, perforated flange is secured to the housing.
 - Spackling compound is applied over flange for finished appearance.

- Options:**
- Patented aluminum ring sets and locking devices.
 - Pull down yokes.
 - Filter rings and shielding cylinders.
 - Filter media: up to two 1/8" (3mm) thick filter per light source.
 - Lutron Athena Wireless Node (white or black finish available).

Model # example: MTL5-4-LEDDW-507-17-1830-1-TI-SQ-AWNR-WH-AT-IC

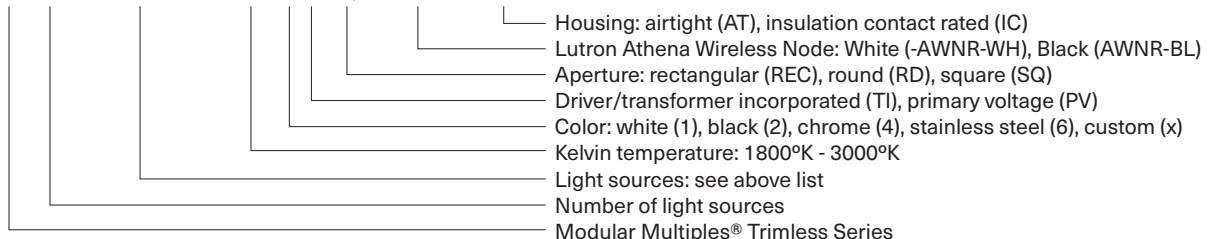

Modular Multiples®

The Original Multiple Light Family of Fixtures



Available LED Modules

Model Number	Watts	Beam Angle	CRI	Lumens	Lumens per watt
LEDDW-507-17	7	17°	90+	419	60
LEDDW-507-30	7	30°	90+	394	56
LEDDW-507-40	7	40°	90+	400	57
LEDDW-508-17	8	17°	90+	575	68
LEDDW-508-30	8	30°	90+	540	70
LEDDW-508-40	8	40°	90+	556	72
LEDDW-509-17	9	17°	90+	705	78
LEDDW-509-30	9	30°	90+	658	73
LEDDW-509-40	9	40°	90+	676	75
LEDDW-511-17	11	17°	90+	830	75
LEDDW-511-30	11	30°	90+	795	72
LEDDW-511-40	11	40°	90+	818	74
LEDDW-713-20	13	20°	90+	1,211	93
LEDDW-713-30	13	30°	90+	1,194	92
LEDDW-713-40	13	40°	90+	1,123	86
LEDDW-713-55	13	55°	90+	1,167	90
LEDDW-719-20	19	20°	90+	1,689	84
LEDDW-719-30	19	30°	90+	1,676	84
LEDDW-719-40	19	40°	90+	1,599	80
LEDDW-719-55	19	55°	90+	1,659	83
LEDDW-726-20	26	20°	90+	2,217	85
LEDDW-726-30	26	30°	90+	2,204	85
LEDDW-726-40	26	40°	90+	2,107	81
LEDDW-726-55	26	55°	90+	2,227	86
LEDDW-730-20	30	20°	90+	2,539	85
LEDDW-730-30	30	30°	90+	2,493	83
LEDDW-730-40	30	40°	90+	2,379	79
LEDDW-730-55	30	55°	90+	2,491	83
LEDDW-936-30	36	30°	90+	3,032	84
LEDDW-936-45	36	45°	90+	3,018	84
LEDDW-936-55	36	55°	90+	3,090	86
LEDDW-936-90	36	90°	90+	3,157	88
LEDDW-940-30	40	30°	90+	3,325	83
LEDDW-940-45	40	45°	90+	3,308	83
LEDDW-940-55	40	55°	90+	3,428	86
LEDDW-940-90	40	90°	90+	3,449	86

Modular Multiples®

The Original Multiple Light Family of Fixtures

Fixture Options

Extendable Yokes

ADD -EY TO END OF MODEL NUMBER

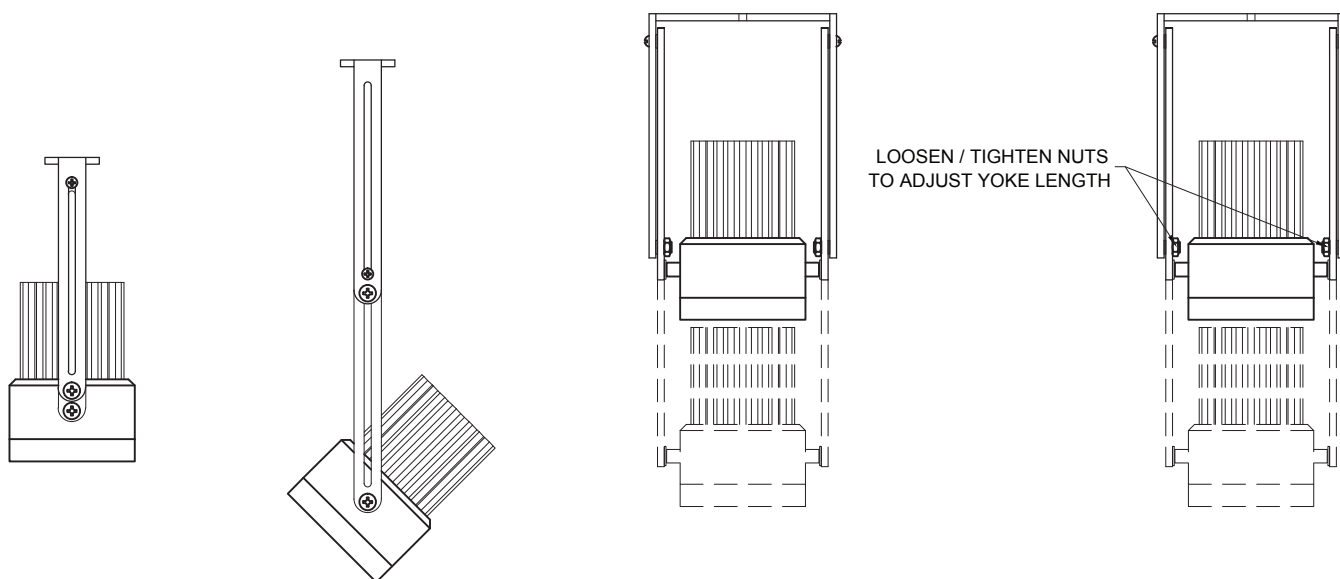

Shielding Options

ADD SHIELDING OPTION CODE (BELOW) TO END OF MODEL NUMBER

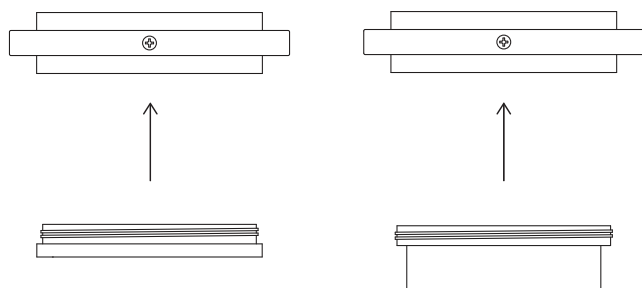

FILTER RING (STANDARD)

SHIELDING CYLINDER (-CY)

Lutron Athena Wireless Nodes

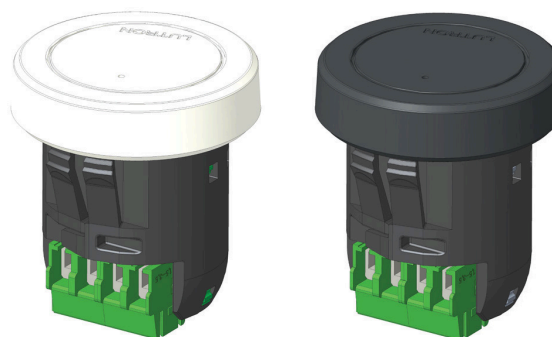

ATHENA WIRELESS NODE
WHITE (AWN-WH)

ATHENA WIRELESS NODE
BLACK (AWN-BL)

Filter Media

ADD FILTER MEDIA CODE (BELOW) TO END OF MODEL NUMBER

